



R22 & R407C

# AIRSTAGE™

Variable Refrigerant Flow System  
Multi Air Conditioning System for Buildings

## The Intelligent Choice in Comfort

### S SERIES



ISO 9001  
Certified number:09 100 79269  
Fujitsu General (Shanghai) Co., Ltd.



ISO 14001  
Certified number:104692  
Fujitsu General (Shanghai) Co., Ltd.



ISO 9001  
Certified number:09 100 89394  
Fujitsu General (Thailand) Co., Ltd.

ISO 14001  
Certified number:09 104 9245  
Fujitsu General (Thailand) Co., Ltd.



All products specified in this brochure comply with the Australian Communications Authority's (ACA) requirements for Electromagnetic Compatibility (EMC).

AIRSTAGE™ is a worldwide trademark of FUJITSU GENERAL LIMITED.

\*Microsoft® and Windows® are registered trademarks of Microsoft Corporation in the United States.

\*Adobe® and Acrobat Reader® are registered trademarks of Adobe Systems Incorporated in the United States.

\*Intel® Pentium® and Celeron® are registered trademarks of Intel Corporation or its subsidiaries in the United States.

\*AMD Athlon™ and AMD Duron™ are registered trademarks of Advanced Micro Devices, Inc.

\*Echelon®, LON®, LONWORKS®, LonTalk®, Neuron®, 3120®, 3150®, LNS®, iLON®, LonMaker® and the Echelon logo are trademarks of Echelon Corporation registered in the United States and other countries.

\*BACnet® is a registered trademark of the American Society of Heating Refrigeration and Air Conditioning Engineers (ASHRAE).

\*An XLON® USB adaptor is provided. (XLON® is a registered trademark of DH electronics company GmbH.)

Product specifications are subject to change without notice.

Copyright © 2002-2005 Fujitsu General Limited. All rights reserved.

Distributed by :

### FUJITSU GENERAL LIMITED

1116, Suenaga, Takatsu-ku, Kawasaki 213-8502, Japan  
URL : <http://www.fujitsugeneral.co.jp/English/>

VB008E/02 Printed in Japan

FUJITSU GENERAL LIMITED

# Building air conditioning developed to

Providing highly efficient, energy-saving operation.

## HEAT PUMP & COOLING ONLY SERIES



A high-performance operating system utilising innovative triple high-efficiency compressors and advanced refrigerant flow control technology (Power Balance Technology). The result is superior energy savings and impressively low operating noise. Capable of connecting up to 13 (22.4kW) or 16 (28kW) indoor units to one outdoor unit. Employs environmentally friendly R407C refrigerant.



### OUTDOOR UNITS LINE UP



Heat Pump Type	Cooling Only Type	Heat Pump Type	Cooling Only Type
AO90TPBMF(28kW)	AO90EPBMF(28kW)	AO90RPBMF(28kW)	AO90APBMF(28kW)
AO72TPBMF(22.4kW)	AO72EPBMF(22.4kW)	AO72RPBMF(22.4kW)	AO72APBMF(22.4kW)

### INDOOR UNIT

#### INDOOR UNITS LINE UP

Choose the right indoor unit to match the building requirements. Various combinations of indoor unit type and capacity 12 types 45 models, ranging from 2.15kW to 17.0kW.



Cassette Type (Compact) Compact design for easy installation and maintenance see page 26	Cassette Type Slim cassette designed for restricted ceiling voids. Compact but powerful for all user applications. see page 27	Duct Type (Compact) Equally suitable for ceiling installation or at floor level. see page 28	Duct Type Ultra-slim duct air conditioner for those tight ceiling spaces. see page 28	High Static Pressure Duct Type High static pressure duct type with no installation restrictions. see page 29
--	---	--	---	--

### RB (Refrigerant Branch) Unit



Multi Type  
Model : UTF-Y90A4A



Single Type  
Model : UTF-Y54A1A

### Separation tube

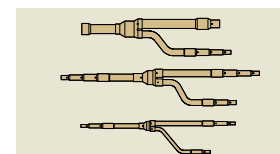

For Heat recovery  
Model : UTR-BP90MA  
UTR-BP54MA  
Separation tubes are available for installation as necessary.

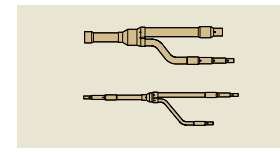

For Heat pump / Cooling only  
Model : UTR-BP90TA  
UTR-BP54TA  
Separation tubes are available for installation as necessary.

### Header

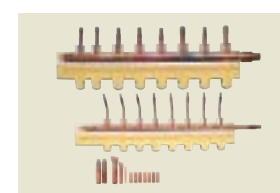

For Heat pump / Cooling only  
Model : UTR-HD908A  
For Heat recovery  
Model : UTR-HD908R  
Headers are available for installation as necessary.  
\*Reducer is attached to each header kit.

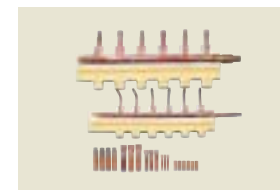

Heat pump / Cooling only  
Model : UTR-HD906A  
For Heat recovery  
Model : UTR-HD906R  
Headers are available for installation as necessary.  
\*Reducer is attached to each header kit.

### Grille kit

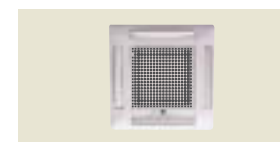

Model: UTG-UDYD-W  
UTG-UDGD-W  
Grille for compact cassette type indoor unit.

### Flange



[Square]  
Model : UTD-SF045T  
For low pressure duct type  
205 x 1,063, L=40 (mm)



[Round]  
Model : UTD-RF204  
For low pressure duct type  
φ195 (φ205), L=85 (mm)

### Outlet chamber

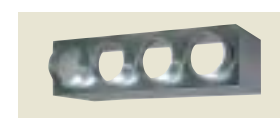

Model : UTD-BC200  
φ195 (φ200), L=85,  
Base size: H x W x D (mm)  
297 x 1,066 x 400

### Flexible duct

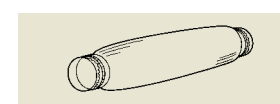

Model : UTD-RD202  
For high static pressure duct type  
φ200, L=2m

### Drain water riser kit

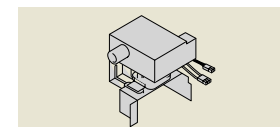

Model : UTR-DPB241  
For ceiling type

### Long-life filter

Model : UTD-LF270  
For low static pressure duct type  
Model : UTD-LF400  
For high static pressure duct type

### Remote sensor unit



Model : UTD-RS100  
Thermo-sensor for sensing the temperature of arbitrary place in the room



# Optional Parts

As for the other optional parts, refer to the other page of this catalog.

# care for people and the environment

Non-inverter system free of electrical noise emissions.

## Network Converter Model : UTR-YRDA



• This network converter is to be used for connecting single split system or group remote controller with the VRF system.  
 • Please select the function by switching the dip switch during the installation work.  
 Dimensions (mm)  
 (H x W x D) : 67 x 288 x 211  
 Weight (g) : 1,500

• Split type systems can be controlled from a central remote controller or PC controller by connecting it to the VRF's network converter.  
 • Standard remote controller and central remote controller provide On/Off control, master control, temperature and fan control, etc.  
 • Up to 16 single units can be connected to and controlled with Network converter.  
 • Up to 100 units of Network converter can be connected in a single VRF transmission system.

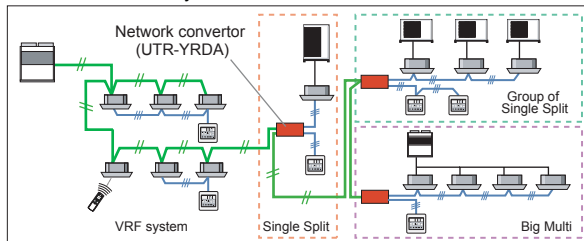

• For connection between Group remote controller and VRF system.



## BACnet® Gateway [Software] Model : UTR-YLBA

• The central control of maximum 1600 indoor units can be realized by connecting the VRF system to the BACnet®, a global standard of the open network  
 • ANSI / ASHRAE Standards 135-2001 BACnet Application Specific Controller (B-ASC) BACnet® / IP over Ethernet  
 • It can be connected up to 4 systems (1600 indoor units / 400 outdoor units) for 1 gateway.  
 • It can be corresponded to the large-scale buildings and hotels etc.

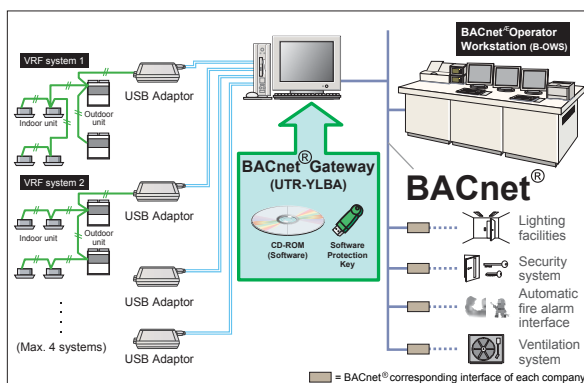

\*USB Adaptor is XLON® USB Adaptor of DH electronics company.  
 \*\*Twisted pair cable [22AWG(0.65mm) Level 4 shielded cable recommendation]

## Network Converter Model : UTR-YLLA



Dimensions (mm)  
 (H x W x D) : 67 x 288 x 211  
 Weight (g) : 1,500

• For connection between our LONWORKS® system and a LONWORKS® open network for the management of a small to medium-sized BMS and VRF system.  
 • By using the UTR-YLLA, the VRF system can be centrally controlled or monitored from a BMS with a LONWORKS® interface.  
 • Up to 128 Indoor units can be connected to 1 unit of Network Converter.

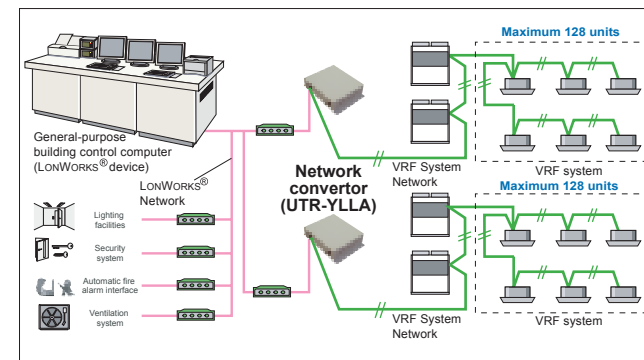

## Transmission Adaptor Model : UTR-YTMA



Dimensions (mm)  
 (H x W x D) : 100 x 288 x 110  
 Weight (g) : 1,300

• For the air condition of the medium and large size building, the control software can control and monitor the air conditioners together with the ones in the other buildings.  
 • This device enables control by other equipment via an Inter Link cable.

## Signal Amplifier Model : UTR-YRPC



Dimensions (mm)  
 (H x W x D) : 67 x 288 x 211  
 Weight (g) : 1,500

• If the total length of Transmission Line exceeds 500m, or if the number of units exceeds 62 units, a Signal Amplifier is required.  
 • By using this unit, it can connect the following number of each units,  
 (1) Transmission Line : Max. 2000m  
 (2) Connectable Units : Max. Indoor Unit : 400 units  
 Max. Outdoor Unit : 100 units  
 Max. Central Remote Controller : 16 unit

• Up to 8 signal amplifiers can be installed in a single VRF system.



**HEAT RECOVERY SERIES**

A high-performance operating system utilising innovative triple high-efficiency compressors and advanced refrigerant flow control technology (Power Accumulation Technology). With heat recovery operation, cooling and heating can be performed simultaneously and automatically within the same refrigerant system. This approach provides maximum energy efficiencies. Capable of connecting up to 16 (28kW) indoor units to one outdoor unit. Employs environmentally friendly R407C refrigerant.

### OUTDOOR UNIT



Heat Recovery Type  
 AO90MPAMF(28kW)

### Floor & Ceiling Universal Type



This slim unit can be ceiling mounted or installed floor standing. Features double auto swing louvers.

see page 29

### Ceiling Type



Attractive design and ultra-slim build still permits extra wide air flow. Features double auto swing louvers and extremely quiet.

see page 30

### Wall Mounted Type (Compact)



Vertical and horizontal symmetrical design matched to the interior decor.  
 • Wall Mounted Type (Compact) indoor unit can't be operated in the Heat Recovery Type System.

see page 30

### Wall Mounted Type



"Double Auto Swing" feature provides Omni-Directional Air Flow control

see page 31

### Ceiling Wall Type



Discreet air intake is part of its attractive design. Double auto swing louvers.

see page 31

## New operating system achieves high stan

- R407C**
  - Heat Pump Type: AO90TPBMF(28kW), AO72TPBMF(22.4kW)
  - Cooling Only Type: AO90EPBMF(28kW), AO72EPBMF(22.4kW)
- R22**
  - Heat Pump Type: AO90RPBMF(28kW), AO72RPBMF(22.4kW)
  - Cooling Only Type: AO90APBMF(28kW), AO72APBMF(22.4kW)

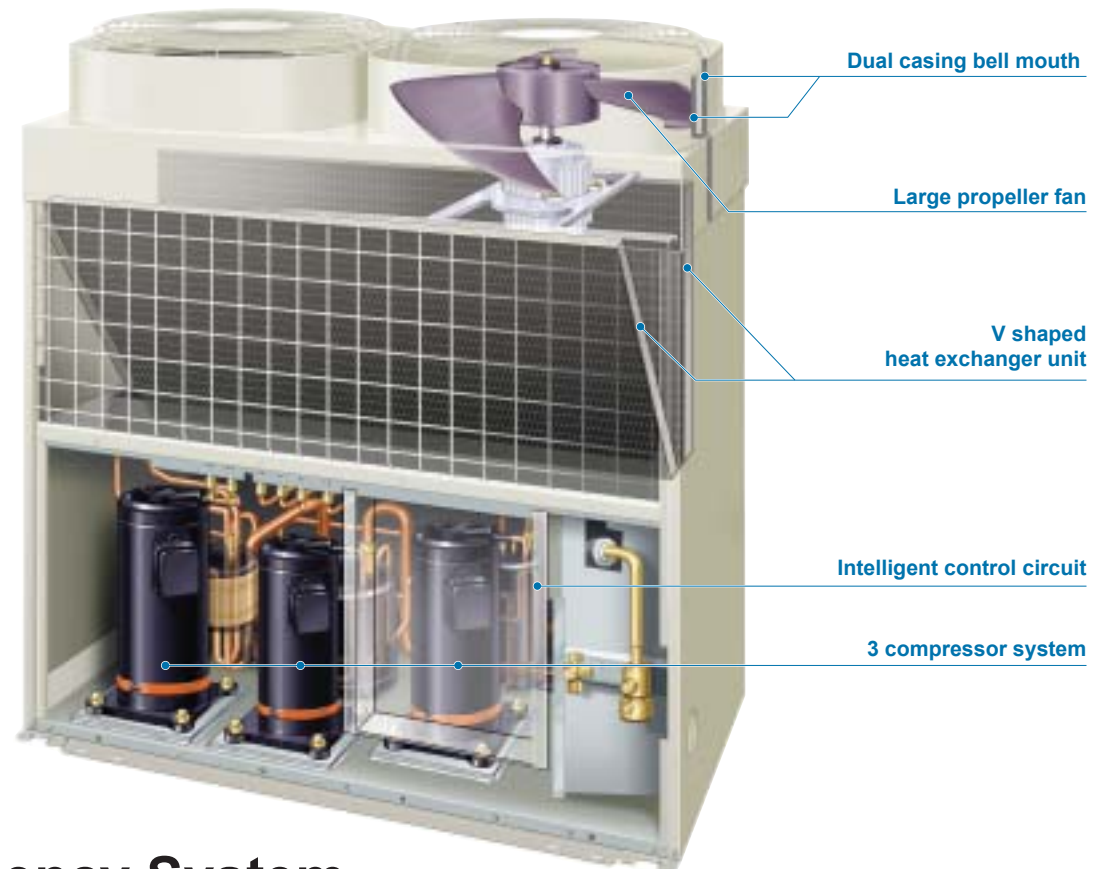

Dual casing bell mouth

Large propeller fan

V shaped heat exchanger unit

Intelligent control circuit

3 compressor system

## High Efficiency System

### New operating system

The newly developed operating system controls the refrigerant flow rate inside the refrigerant circuit through the use of dual control technology, i.e. compressor capacity control technology and power balance control technology. This approach delivers high operating efficiencies through optimum refrigerant flow.

Cooling COP	3.11*
Heating COP	3.71*

\* COP values are based on our own testing method. (AO90TPBMF)

### Compressor Capacity Control

Compressor capacity control is achieved through the optimum balance of three individually rated compressors. This approach is extremely efficient as it provides a wide range of refrigerant flow rate options. Furthermore, by controlling the amount of gas "pumped" by each compressor, the system can accurately adjust refrigerant flow rates.

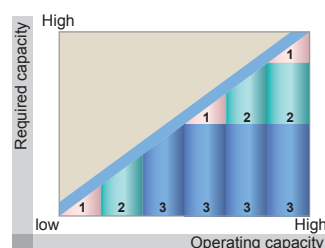

### Power Balance Control

Power balance control technology achieves high operational efficiencies by detecting low pressure (evaporating temperature) during cooling and high pressure (condensing temperature) during heating and precisely controls the optimum refrigerant condition via refrigerant flow rate (capacity). Waste through excessive refrigerant flow is eliminated as is insufficient capacity due to insufficient refrigerant flow rate.

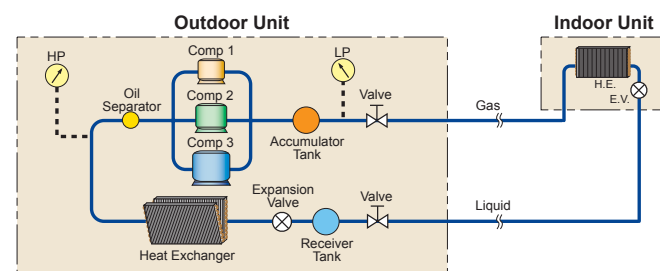

#### Low pressure control for cooling

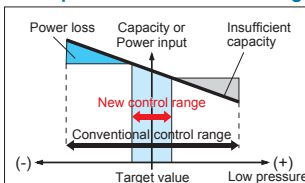

#### High pressure control for heating

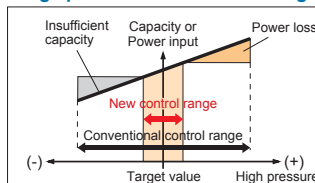

## Web Monitoring Tool [Software]

Model : UTR-YMSA [Option]

### Product features

Trouble-shooting is performed by monitoring each air conditioning unit remotely during periodical system checks.

### Web Monitoring System

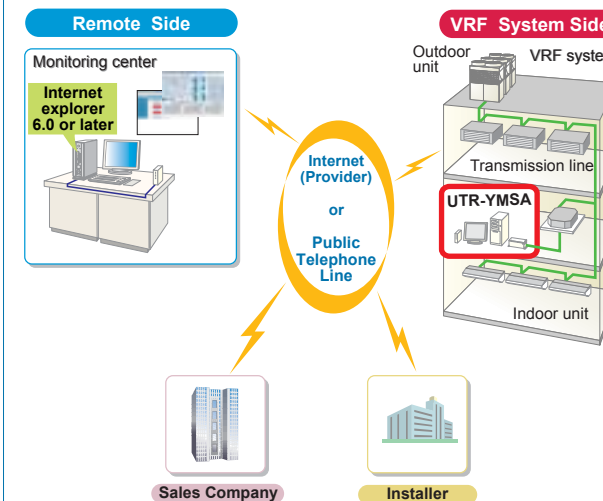

### Features

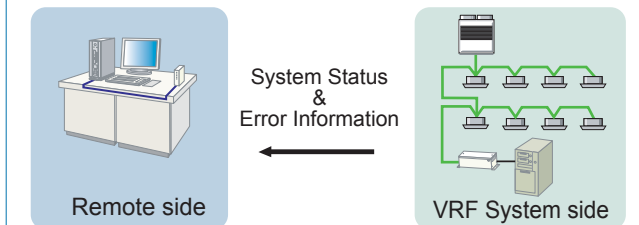

- Error notification can be automatically transmitted to up to several locations by using internet\*.
- Requires either a dedicated internet connection\* or public telephone line.
- Determination of an error occurrence can be made through error warnings and equipment status information obtained from a remote location.

\* Dedicated connection preferred.

### Support 4 VRF system

PC Transmission adaptors (max. four adaptors per PC) permit control and monitoring of up to 1,600 units. Suitable for large-scale buildings or hotels.

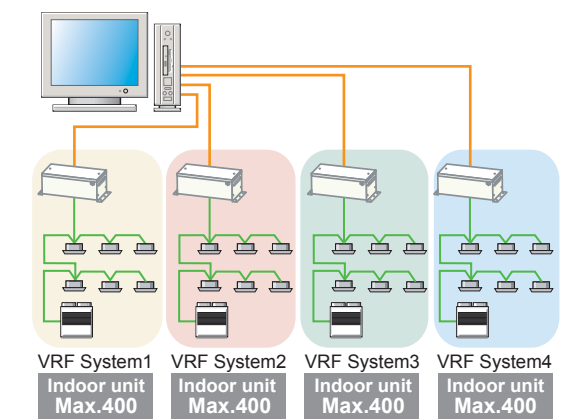

### System components

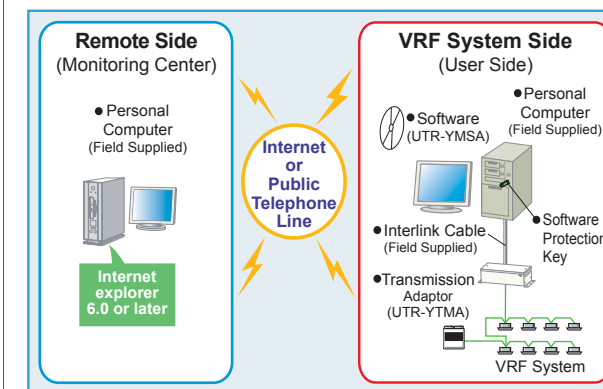

### Requirements of PC for this software

Personal Computer	Operating System	AT compatible machine that runs Microsoft® Windows® · Microsoft® Windows® 2000 Professional (English version / Service pack3 or later) · Microsoft® Windows® XP Professional (English version / Service pack1 or later)
	CPU	Intel® Pentium® / Celeron®, AMD Athlon® / Duro® 1GHz or higher
	HDD	2.1 GB or more
	Memory	512 MB or more
	Interface	Serial port (Max. 4)*1 and USB port
Software	Internet Explorer 6.0 or later / Adobe® Acrobat® Reader 4.0 or later *2	
Hardware	· Interlink cable D-sub 9pin [Field supplied] · Transmission Adaptor (UTR-YTMA)	

### <PACKING LIST>

Packing List	CD-ROM / Software Protection Key
--------------	----------------------------------

\*1 1 port required for each VRF system connected.

\*2 If Internet Explorer is installed on the remote side PC, remote supervision of VRF system status is available.



## Service Tool [Software]

Model : UTR-YSTC [Option]



## Standards in comfort and performance

HEAT PUMP & COOLING ONLY SERIES

### Extensive monitoring and analysis functions for installation and maintenance

- Operational status can be checked and analyzed to detect even the smallest abnormalities.
- Storage of data on system operating status on a PC allows access even from off site.
- Up to 400 units (a single VRF system) can be controlled and monitored for large scale buildings or hotels.

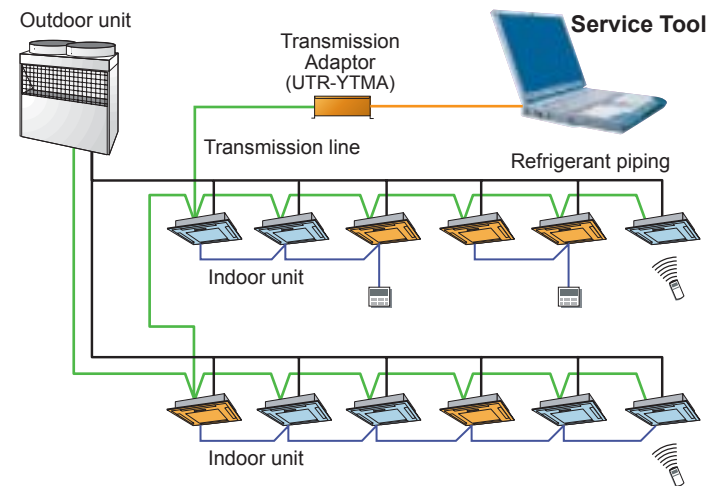

### Functions

#### System equipment List



This list displays all equipment connected to the system. Simple operating status parameters are displayed for instant recognition in the event of problems.

#### Equipment status detail



Current status of each equipment and sensor data can be displayed on a circuit diagram and plotted on a graph. Simply move the cursor along the graph to review past data on the circuit diagram.

#### Commissioning Tool

Extensive test support provided; for maintenance purposes, sensor data can be saved and exported to CSV files that can be read in Microsoft Excel. This is useful in compiling test reports.

#### Error History



Permits review of the current error and provides a history of the previous 50 errors for each piece of equipment.

### Requirements of PC for this software

Personal Computer	Operating System	AT compatible machine that runs Microsoft® Windows® Microsoft® Windows® 2000 Professional (English version / Service pack3 or later) Microsoft® Windows® XP Professional (English version / Service pack1 or later)
	CPU	Intel® Pentium® / Celeron®, AMD Athlon® / Duro™ 1GHz or higher
	HDD	2.1 GB or more
	Memory	256 MB or more
	Interface	Serial port and USB port
Software	Internet Explorer 6.0 or later / Adobe® Acrobat® Reader 4.0 or later	
Hardware	Interlink cable D-sub 9pin [Field supplied] / Transmission Adaptor (UTR-YTMA)	

#### <PACKING LIST>

Packing List	CD-ROM / Software Protection Key
--------------	----------------------------------

### Selectable Operation Mode

#### High power and energy saving

15% Energy saving

High power and energy saving modes are freely selectable and have the effect of varying the outlet air flow temperature by 2 degrees. The energy saving mode delivers 15% energy savings, whereas the high power mode increases capacity by an equal amount.

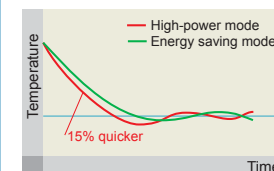

High power mode enables set point to be achieved much quicker (approx 15% faster).

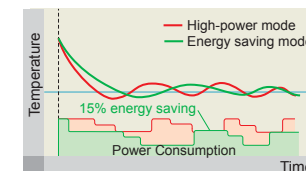

Energy saving mode discreetly adjusts room temperature to achieve a valuable 15% energy saving.

### High Reliability

#### Recovery operation

**Outdoor Unit**  
In the event of compressor failure an alarm is automatically triggered and the remaining compressor(s) will continue to operate, thereby ensuring continuous operation when possible.

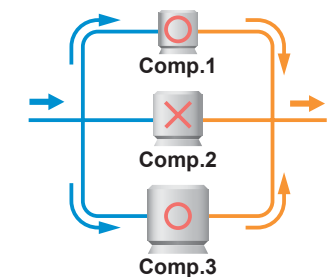

**Indoor Unit**  
Each indoor unit operates independently from the others and is, therefore, not affected by a failure within any part of the network.

#### Oil Recovery operation

After a fixed period of time the oil recovery operation automatically returns accumulated oil found in the refrigerant circuit and indoor units.

### Wide Operating Range

#### Cooling + heating operation at low outdoor temperature of down to -15 °C

Outdoor unit operates over an outdoor temperature range of -15°C to 52°C for cooling and -15°C to 21°C for heating.

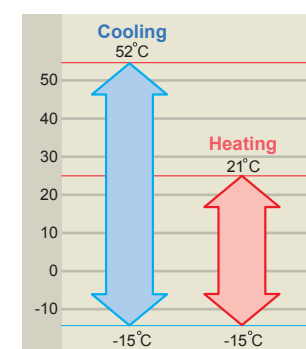

### Surroundings Conscious

#### No Harmonic Disturbances

As our VRF system is not based on inverter technology to control refrigerant flow rate harmonic emissions are almost zero. As a result, it will not interfere with electronic equipment found in the office, factory or power distribution facilities, making it the ideal air conditioning solution for hospitals where harmonic emissions are strictly controlled.

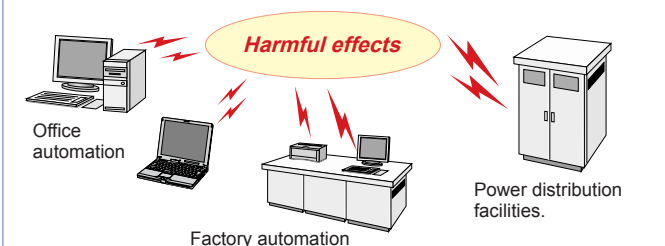

#### Alternative refrigerant

R407C offers greater protection to the environment.

### Super Quiet

#### Low sound pressure level

Operational noise has been reduced yet further through the application of a new dual casing bell-mouth and large fan. When set to silent operation, noise levels can be reduced by 5-6dB(A) compared to normal operation.

	28kW	22.4kW
Normal operation mode	55 dB(A)	54 dB(A)
Silent operation mode	50 dB(A)	48 dB(A)

(380V)

## Maximum comfort from inbuilt flex

**R407C** Heat Recovery Type  
AO90MPAMF(28kW)



### High Efficiency System

#### Operating system

Cooling and heating can be performed simultaneously within the same refrigerant circuit. Energy savings are made by transferring heat between the indoor units when in heat recovery operation.

Cooling COP	2.98*
Heating COP	3.15*

\* COP values are based on our own testing method. (AO90MPAMF)

#### Smooth operation delivering high efficiencies

The configuration of 3 constant speed compressors with differing capacities and power accumulation technology ensure smooth step changes and highly efficient operation.

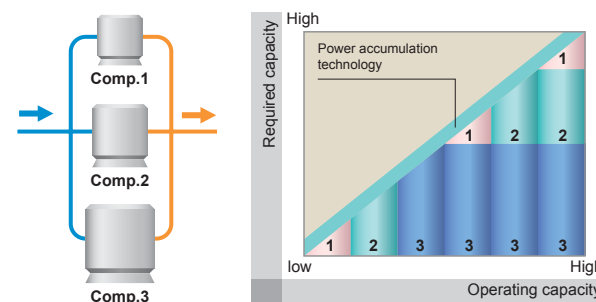

Flow rate between each step is controlled by power accumulation technology

#### Power Accumulation Technology

Flow rate to the indoor unit(s) is controlled through the use of 3 differently rated compressors operating in a sequential step arrangement. While power accumulation technology controls the circulating load of the refrigerant flow between those steps.

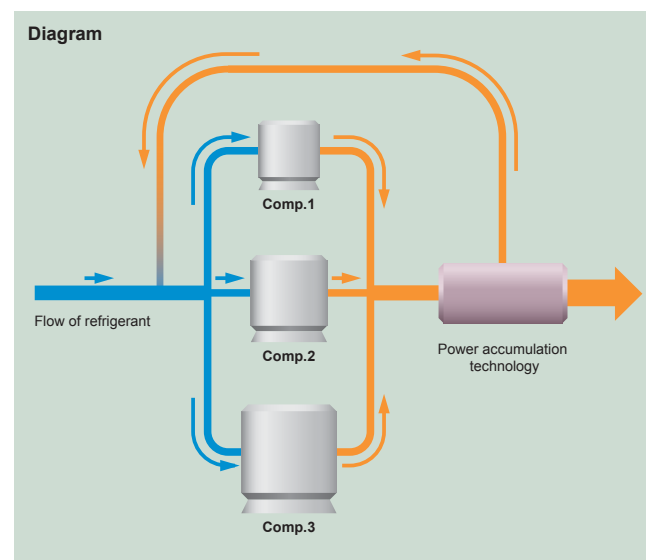

#### Wall Mounted Type (Compact) / Wall Mounted Type

Model	Wall Mounted Type (Compact)				Wall Mounted Type			
	AS7	AS9	AS12	AS14	AS18	AS24	AS30	
Power Source	220-240V~50Hz							
Cooling Capacity	kW	2.15	2.80	3.50	3.80	5.40	6.90	8.00
	BTU / h	7,400	9,600	11,900	13,000	18,400	23,600	27,300
Heating Capacity	kW	2.45	3.10	4.10	4.50	5.60	7.80	8.80
	BTU / h	8,400	10,600	14,000	15,400	19,100	26,600	30,000
Input	W	26	30	35	39	38	50	60
Current	A	0.15	0.16	0.18	0.20	0.18	0.24	0.28
Max. Current	A	0.18	0.19	0.22	0.24	0.22	0.29	0.34
Air Circulation	High	410	450	520	540	840	950	1,050
	Med	380	410	500	510	700	800	940
	Low	350	370	470	490	600	670	780
Fan Speed	High	1,000	1,090	1,250	1,300	1,080	1,190	1,320
	Med	930	1,000	1,200	1,240	940	1,030	1,210
	Low	860	900	1,150	1,180	810	900	1,030
Fan Motor Output	W	16.5				38		
Noise Level (Sound Pressure)	High	30	33	37	38	42	45	48
	Med	28	30	36	37	39	42	45
	Low	26	27	34	35	35	38	42
Fan Type x Q'ty	Cross Flow x 1							
Heat Exchanger	Plate Fin Coil							
Dimensions (H x W x D)	Net	257 x 808 x 187				320 x 1,120 x 220		
	Gross	270 x 850 x 310				348 x 1,240 x 427		
Weights	Net	8				16		
	Gross	10				25		
Pipe Size	Liquid	φ 6.35					φ 9.52	
	Gas	φ 9.52		φ 12.70		φ 15.88		
Pipe Connection Method	Flare							
Operation Range	Cooling	°C 18 to 30						
	Heating	°C 16 to 30						



• Wall Mounted Type (Compact) indoor unit can't be operated in the Heat Recovery Type System.



#### Ceiling Wall Type

Model	Ceiling Wall Type							
	AW7	AW9	AW12	AW14	AW18	AW24	AW30	
Power Source	220-240V~50Hz							
Cooling Capacity	kW	2.15	2.80	3.60	4.30	5.40	6.90	8.00
	BTU / h	7,400	9,600	12,300	14,700	18,400	23,600	27,300
Heating Capacity	kW	2.45	3.10	4.10	4.90	5.60	7.80	8.80
	BTU / h	8,400	10,600	14,000	16,700	19,100	26,600	30,000
Input	W	16	19	20	21	30	40	50
Current	A	0.08	0.09	0.10		0.14	0.19	0.24
Max. Current	A	0.10	0.11	0.12		0.17	0.23	0.29
Air Circulation	High	380	480	600	650	760	900	950
	Med	330	420	520	570	660	780	870
	Low	290	390	470	490	560	650	780
Fan Speed	High	1,090	1,310	950	1,000	1,150	1,300	1,380
	Med	980	1,180	860	910	1,030	1,160	1,280
	Low	900	1,100	800	820	930	1,020	1,180
Fan Motor Output	W	32		35		32		
Noise Level (Sound Pressure)	High	34	35		37	40	44	47
	Med	32		33	35	37	41	45
	Low	30	31		32	34	37	42
Fan Type x Q'ty	Cross Flow x 1							
Heat Exchanger	Plate Fin Coil							
Dimensions (H x W x D)	Net	270 x 1,150 x 285						
	Gross	400 x 1,260 x 380						
Weights	Net	16						
	Gross	20						
Pipe Size	Liquid	φ 6.35					φ 9.52	
	Gas	φ 9.52	φ 12.70		φ 15.88			
Pipe Connection Method	Flare							
Operation Range	Cooling	°C 18 to 30						
	Heating	°C 16 to 30						



Note : Specifications are based on the following conditions.  
Cooling : Indoor temperature of 27°CDB/19°CWB, and outdoor temperature of 35°CDB/24°CWB.  
Heating : Indoor temperature of 20°CDB/15°CWB, and outdoor temperature of 7°CDB/6°CWB.

## Specifications

## High Static Pressure Duct Type

Model		High Static Pressure Duct Type		
		AR36H	AR45H	AR60H
Power Source		220-240V~50Hz		
Cooling Capacity	kW	10.5	12.7	17.0
	BTU / h	36,000	43,500	58,000
Heating Capacity	kW	10.7	13.7	17.6
	BTU / h	36,500	47,000	60,100
Input	W	445	463	733
Current	A	2.35		3.58
Max. Current	A	3.02		4.81
Air Circulation	High	2,000	2,200	3,000
	Med	1,700	1,900	2,750
	Low	1,400	1,600	2,500
Fan Speed	High	760	890	1,150
	Med	690	820	1,075
	Low	630	760	1,000
Fan Motor Output	W	350		500
Noise Level (Sound Pressure)	High	47	48	53
	Med	45	46	52
	Low	43	44	51
Fan Type x Q'ty	Sirocco x 2			
Heat Exchanger	Plate Fin Coil			
Dimensions (H x W x D)	Net	400 x 1,250 x 800		
	Gross	500 x 1,430 x 930		
Weights	Net	75		
	Gross	90		
Pipe Size	Liquid	φ 9.52		
	Gas	φ 19.05		
Pipe Connection Method	Flare			
Operation Range	Cooling	18 to 30		
	Heating	16 to 30		



## Floor &amp; Ceiling Universal Type / Ceiling Type

Model		Floor & Ceiling Universal Type					Ceiling Type			
		AB12	AB14	AB18	AB24	AB30	AB36	AB45	AB54	
Power Source		220-240V~50Hz								
Cooling Capacity	kW	3.5	4.05	5.3	6.6	8.8	10.5	12.7	14.1	
	BTU / h	11,900	13,800	18,100	22,500	30,000	36,000	43,500	48,200	
Heating Capacity	kW	4.1	5.0	5.6	7.7	9.1	10.7	13.7	15.8	
	BTU / h	14,000	17,100	19,100	26,300	31,000	36,500	47,000	54,000	
Input	W	57		88		124	144	160	180	
Current	A	0.25		0.38		1.14	1.16	1.17		
Max. Current	A	0.30		0.45		1.36	1.39	1.40		
Air Circulation	High	640	770	900	1,620	1,890	2,110	2,350		
	Med	560	680	780	1,540	1,710	1,890	2,810		
	Low	480	560	660	1,360	1,450	1,630	1,900		
Fan Speed	High	850	1,030	1,180	850	1,000	1,100	1,250		
	Med	760	890	1,040	800	900	1,000	1,150		
	Low	670	770	900	700	750	850	1,000		
Fan Motor Output	W	16	30	40	160					
Noise Level (Sound Pressure)	High	40	46	49	41.5	47	50	52		
	Med	37	41.5	45	38	44	48	50		
	Low	34	37	41	34.5	39	44	46		
Fan Type x Q'ty	Sirocco x 2					Sirocco x 4				
Heat Exchanger	Plate Fin Coil									
Dimensions (H x W x D)	Net	199 x 990 x 655					240 x 1,660 x 700			
	Gross	320 x 1,150 x 790					318 x 1,800 x 790			
Weights	Net	28			30	48		49		
	Gross	39			39	61		62		
Pipe Size	Liquid	φ 6.35					φ 9.52			
	Gas	φ 12.70		φ 15.88		φ 19.05				
Pipe Connection Method	Flare									
Operation Range	Cooling	18 to 30								
	Heating	16 to 30								



Note : Specifications are based on the following conditions.  
 Cooling : Indoor temperature of 27°CDB/19°CWB, and outdoor temperature of 35°CDB/24°CWB.  
 Heating : Indoor temperature of 20°CDB/(15)°CWB, and outdoor temperature of 7°CDB/6°CWB.

## Reliability

HEAT RECOVERY SERIES

## Wide Operating Range

## Cooling operation at outdoor temperatures down to -5°C

Outdoor unit operates over an outdoor temperature range of -5 °C to 52 °C for cooling and -15 °C to 21 °C for heating.

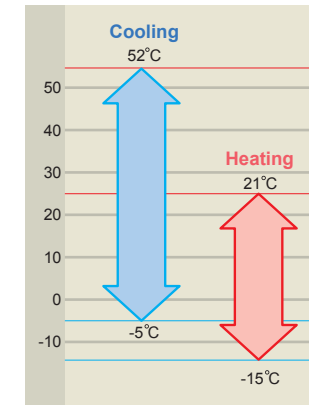

## Super Quiet

## Low sound pressure level

Operational noise has been reduced yet further through the application of a new dual casing bell-mouth and large fan. When set to silent operation, noise levels can be reduced by 5dB(A) compared to normal operation.

Normal operation mode	55 dB(A)
Silent operation mode	50 dB(A)

(380V)

## Comfortable Operation

## Heat Recovery operation

Heat Recovery operation is a cooling/heating free operation system, cooling and heating can be performed simultaneously in the same refrigerant system according to user needs. At the moment, The Heat Recovery operation is an extremely superior type that provides a still greater energy saving effect by moving heat between indoor units that are performing the cooling and heating operations. This is by having the compressors act like a pump.



## High Reliability

## Recovery operation

## Outdoor Unit

In the event of compressor failure an alarm is automatically triggered and the remaining compressor(s) will continue to operate, thereby ensuring continuous operation when possible.

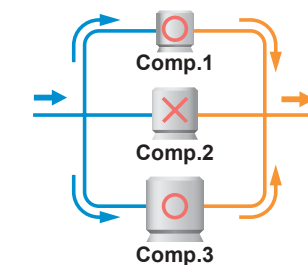

## Indoor Unit

Each indoor unit operates independently from the others and is, therefore, not affected by a failure within any part of the network.

## Oil Recovery operation

After a fixed period of time the oil recovery operation automatically returns accumulated oil found in the refrigerant circuit and indoor units.

## Surroundings Conscious

## No Harmonic Disturbances

As our VRF system is not based on inverter technology to control refrigerant flow rate harmonic emissions are almost zero. As a result, it will not interfere with electronic equipment found in the office, factory or power distribution facilities, making it the ideal air conditioning solution for hospitals where harmonic emissions are strictly controlled.

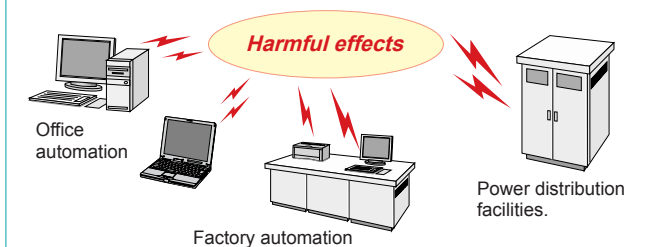

## Alternative refrigerant

R407C offers greater protection to the environment.



# The VRF's quality features

## Economical Operation

VRF differs from traditional ventilation and chiller systems being an economical multi air conditioning system that has the ability to exactly match air conditioning to the needs of the space.

Whether operating continuously as required within commercial buildings and public facilities or with large load variations for hotels, etc the VRF maintains optimum operation for that building. That means optimum comfort for the occupants at minimum energy expenditure.

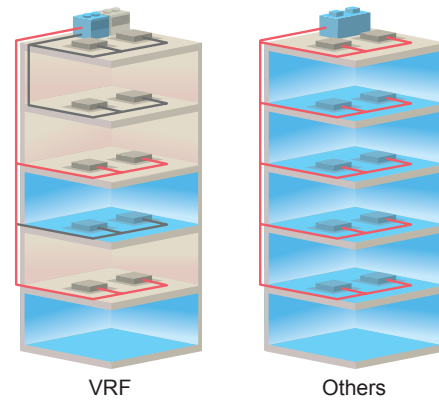

## Easy Installation

System installation could not be easier, simply connect the refrigerant piping and data transmission line. Repositioning indoor units is just as easy.

## Compact Size

Save space by installing in tandem.

Setting size **5.72 (Unit : m<sup>2</sup>)**



Offering one of the smallest footprints available the outdoor unit provides 84kW(28kW x 3) capacity within a very tight space.

## Free-up Valuable Space

The VRF allows the height difference between outdoor and indoor units to be as much as 50m. Consequently for a 15 storey building, for example, all of the outdoor units can be installed out of the way on the roof, freeing-up valuable interior space.

## Easy Maintenance

VRF maintenance is easy and simple! Constant monitoring by a PC and integral software service tools can predict faults enabling the service engineer to rectify before a failure occurs.

Service Tool [Software] Model : UTR-YSTC



Service Tool monitors the entire VRF system.

Extensive monitoring and analysing functions.

- Operational status can be checked and analysed to detect even the smallest abnormality.
- By storing system operation status in a PC, data can be checked even when offline.

### Cassette Type (Compact) / Cassette Type

Model	Cassette Type (Compact)						Cassette Type						
	AU7	AU9	AU12	AU14	AU18	AU20	AU25	AU30	AU36	AU45	AU54		
Power Source	220-240V~50Hz												
Cooling Capacity	kW	2.15	2.80	3.60	4.00	5.00	5.70	7.05	8.80	10.5	12.7	14.1	
	BTU / h	7,400	9,600	12,300	13,700	17,100	19,500	24,100	30,000	35,800	43,400	48,100	
Heating Capacity	kW	2.45	3.10	4.10	4.50	5.45	5.80	7.85	9.10	10.7	13.7	15.8	
	BTU / h	8,400	10,600	14,000	15,400	18,600	19,800	26,800	31,100	36,500	46,800	53,900	
Input	W	28		52		104		140		190		219	
Current	A	0.13		0.23		0.60		0.67		0.92		0.95	
Max. Current	A	0.15		0.27		0.72		0.80		1.12		1.14	
Air Circulation	High	530		580		1,000		1,200		1,650		1,780	
	Med	480		520		840		940		1,050		1,550	
	Low	410		460		700		780		1,100		1,300	
Fan Speed	High	630		690		750		490		580		680	
	Med	570		610		640		390		480		550	
	Low	480		540		540		330		390		470	
Fan Motor Output	W	9		10		15		42		90			
Noise Level (Sound Pressure)	High	38		41		44		44		48		52	
	Med	35		37		38		42		44		47	
	Low	31		34		35		39		41		43	
Fan Type x Q'ty	Turbo x 1												
Heat Exchanger	Plate Fin Coil												
Dimensions (H x W x D)	Net	230 x 570 x 570						246 x 830 x 830			296 x 830 x 830		
	Gross	280 x 710 x 750						355 x 1,060 x 1,025			455 x 1,060 x 1,025		
Weights	Net	18						34			40		
	Gross	23						45			60		
Pipe Size	Liquid	φ 6.35						φ 9.52					
	Gas	φ 9.52		φ 12.70		φ 15.88		φ 19.05					
Pipe Connection Method	Flare												
Operation Range	Cooling	18 to 30											
	Heating	16 to 30											

### Duct Type (Compact) / Duct Type

Model	Duct Type (Compact)					Duct Type							
	AR7	AR9	AR12	AR14	AR18	AR25	AR30	AR36	AR45				
Power Source	220-240V~50Hz												
Cooling Capacity	kW	2.15	2.80	3.50	4.00	5.30	7.05	8.80	10.5	12.7			
	BTU / h	7,300	9,600	11,900	13,700	18,100	24,100	30,000	36,000	43,500			
Heating Capacity	kW	2.45	3.10	4.10	4.80	5.60	7.85	9.10	10.7	13.7			
	BTU / h	8,400	10,600	14,000	16,400	19,100	26,800	31,000	36,500	47,000			
Input	W	40	43	34	50	62	155	240	265	315			
Current	A	0.21		0.20		0.27		0.68		1.06		1.44	
Max. Current	A	0.25		0.24		0.32		0.84		1.58		1.84	
Air Circulation	High	340	420	460	640	750	1,200	1,650	2,000	2,200			
	Med	320	390	430	560	700	1,100	1,550	1,800	2,000			
	Low	290	360	390	480	640	1,000	1,350	1,600	1,800			
Fan Speed	High	780	960	640	840	960	890	1,240	1,280	1,320			
	Med	720	880	610	740	900	820	1,140	1,200	1,270			
	Low	660	810	580	650	840	745	1,040	1,130	1,200			
Fan Motor Output	W	12	14	16	18	21	70	275					
Noise Level (Sound Pressure)	High	31	35	28	34	36	44	47		49			
	Med	28	33	27	32	35	42	45		47			
	Low	26	31	26	30	33	40	43		45			
Fan Type x Q'ty	Sirocco x 1					Sirocco x 2							
Heat Exchanger	Plate Fin Coil												
Dimensions (H x W x D)	Net	217 x 663 x 595				217 x 953 x 595			270 x 1,210 x 700				
	Gross	324 x 785 x 686				324 x 1,075 x 686			330 x 1,300 x 790				
Weights	Net	18				25			43		45		
	Gross	22				29			58		60		
Pipe Size	Liquid	φ 6.35					φ 9.52						
	Gas	φ 9.52		φ 12.70		φ 15.88		φ 19.05					
Pipe Connection Method	Flare												
Operation Range	Cooling	18 to 30											
	Heating	16 to 30											

Note : Specifications are based on the following conditions.  
 Cooling : Indoor temperature of 27°CDB/19°CWB, and outdoor temperature of 35°CDB/24°CWB.  
 Heating : Indoor temperature of 20°CDB/15°CWB, and outdoor temperature of 7°CDB/6°CWB.



## Specifications

### Heat Pump / Cooling Only Type

Model		Refrigerant Type : R407C				Refrigerant Type : R22			
		AO90 TPBMF	AO72 TPBMF	AO90 EPBMF	AO72 EPBMF	AO90 RPBMF	AO72 RPBMF	AO90 APBMF	AO72 APBMF
Power Source		3 phase, 380 - 415V, 50Hz							
Total Capacity	Cooling	28.0	22.4	28.0	22.4	28.0	22.4	28.0	22.4
	Heating	31.5	25.2	—	—	31.5	25.2	—	—
Total Input Watts	Cooling	9.03	7.23	9.03	7.23	9.03	7.23	9.03	7.23
	Heating	8.50	7.64	—	—	8.50	7.00	—	—
E.E.R.	Cooling	3.10							
	Heating	3.71	3.30	—	—	3.71	3.60	—	—
Heat Exchanger		Plate Fin Coil							
Fan Speed	High	730							
	Low	360							
Air Circulation	High	9800							
Fan Type x Qty		Propeller x 2							
Fan Motor Output		150 x 2							
Compressor	Motor Output	1.5/3.4/4.9	1.5/2.5/4.8	1.5/3.4/4.9	1.5/2.5/4.8	1.5/3.7/5.0	1.5/2.5/4.8	1.5/3.7/5.0	1.5/2.5/4.8
	Protection	Internal Protector(OCR) / High Pressure Relief Valve							
Dimensions(H x W x D)	Net	1,380 x 1,300 x 650							
	Gross	1,535 x 1,400 x 770							
Weights	Net	285	278	284	277	296	278	292	274
	Gross	321	314	320	313	332	314	328	310
Noise Level (Sound Pressure)	380V	55	54	55	54	55	54	55	54
	415V	57	56	57	56	57	56	57	56
Refrigerant	Type	R407C				R22			
	Charge	12	10	12	10	12	10	12	10
Pipe	Size	Liquid	φ 12.70						
		Suction Gas	φ 28.58						
	Max Length	100							
	Max Height	50							
Operation Range (Outdoor)	Cooling	-15 to 52				21 to 52			
	Heating	-15 to 21				-15 to 21			



### Heat Recovery Type

Model		Refrigerant Type : R407C			
		AO90MPAMF			
Power Source		3 phase, 380 - 415V, 50Hz			
Total Capacity	Cooling	28.0			
	Heating	31.5			
Total Input Watts	Cooling	9.40			
	Heating	10.0			
E.E.R.	Cooling	2.98			
	Heating	3.15			
Heat Exchanger		Plate Fin Coil			
Fan Speed	High	730			
	Low	360			
Air Circulation	High	9,800			
Fan Type x Qty		Propeller x 2			
Fan Motor Output		150 x 2			
Compressor	Motor Output	1.5 / 3.4 / 5.0			
	Protection	Internal Protector (OCR) High Pressure Relief Valve			
Dimensions (H x W x D)	Net	1,380 x 1,300 x 650			
	Gross	1,535 x 1,400 x 770			
Weights	Net	306			
	Gross	343			
Noise Level (Sound Pressure)		57			
Refrigerant	Type	R407C			
	Charge	10.0			
Pipe	Size	Liquid	φ 12.70		
		Discharge Gas	φ 19.05		
	Suction Gas	φ 28.58			
	Max. Length	100			
Max. Height	50				
Operation Range (Outdoor)	Cooling	-5 to 52			
	Heating	-15 to 21			



Note : Specifications are based on the following conditions.  
 Cooling : Indoor temperature of 27°CDB/19°CWB, and outdoor temperature of 35°CDB/24°CWB.  
 Heating : Indoor temperature of 20°CDB/15°CWB, and outdoor temperature of 7°CDB/6°CWB.

 HEAT PUMP &  
 COOLING ONLY  
 SERIES

 HEAT  
 RECOVERY  
 SERIES

## Flexible Construction

Infinitely variable selection from 12 different types and 45 models of indoor unit plus 9 outdoor units.  
 The outdoor unit is capable of handling 130% capacity, easily accommodating future system changes and expansion.

### System upgrade network parts

\*See details on page 38.

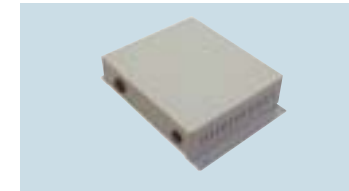

#### Network Converter

Model : UTR-YRDA (Option)

With this converter, split type systems can be controlled by PC controller or a central remote controller.



#### Network Converter (LONWORKS®)

Model : UTR-YLLA (Option)

By using the UTR-YLLA, the VRF system can be centrally controlled or monitored from a BMS with a LONWORKS® interface.

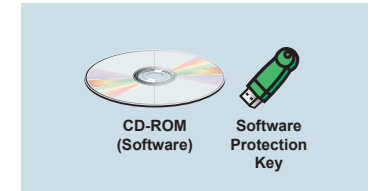

#### BACnet® Gateway [Software]

Model : UTR-YLBA

The central control of maximum 1600 indoor units can be realized by connecting the VRF system to the BACnet®, a global standard of the open network

### Comparison with the features between VRF and other system

		VRF system	Other system
Basic	Heat Transfer Media	Refrigerant	Water
	Heat Carrying Capacity	49 kcal/kg (10 times higher than chiller)	5 kcal/kg
Energy Saving	Energy Efficiency	High Energy Efficiency Direct heat transfer from refrigerant to room air	Less Energy Efficiency 1st. stage heat transfer : From refrigerant to water 2nd. stage heat transfer : From water to room air
	Overall Heat Transfer Efficiency	High Between refrigerant & room air	Low Between water & room air
	Operation Time	Short (To reach set room temperature)	Long (To reach set room temperature)
	Energy Transmission Loss	Low Heat loss through connecting pipe from outdoor unit to indoor unit	High Heat loss through connecting pipe from chilled water unit to indoor fan coil unit
	System Efficiency (Partial Load Operation)	High (Refrigerant flow reduced due to compressor power reduction)	Low Compressor power consumption reduced but constant water circulation pump consumption
Additional Benefits	Heating Operation Performance (Below 0°C)	Sufficient (Discharge air temperature from indoor unit above 37°C)	Insufficient (Except connecting water heating boiler)
	Flexibility (Choice of Fan coil Unit)	More Flexible	Less Flexible
	Maintenance	simpler and easier than "other systems"	Periodic

Note: "Other system" means water chiller system.

# For consultants and building des

The VRF system offers an infinitely variable choice of indoor and outdoor units: 12 types and 45 models of indoor units together with a choice of 9 outdoor units. Plus 2-pipe (heat pump, cooling only) and 3-pipe (heat recovery) systems are available providing inbuilt reliability. VRF offers flexible and quick air conditioning design solutions supported by low running and maintenance costs, particularly when compared to conventional systems.

INDOOR UNIT

## Design Flexibility

### Shorten the design time

Compared to conventional building air conditioning systems, VRF system design is fast thanks to the simplicity of the outdoor unit, refrigerant piping and data transmission - and the VRF can control up to 100 outdoor units and 400 indoor units. Refrigerant piping between outdoor and indoor units can extend up to 100m in length with a height difference of 50m, making 15-storey buildings easy to accommodate. So, system design is uncomplicated and fast.

### Long piping for high-rise buildings

Vertical lift between outdoor unit and indoor units : 50m maximum.

※When outdoor unit is located above indoor unit.

When outdoor unit is located below the indoor unit the height difference is 40m maximum.

Vertical lift between indoor unit and indoor units : 15m maximum.

Actual pipe length : 100m maximum.

Equivalent pipe length : 120m maximum.

Total pipe length : 200m maximum.

### Heat Pump / Cooling Only Heat Recovery

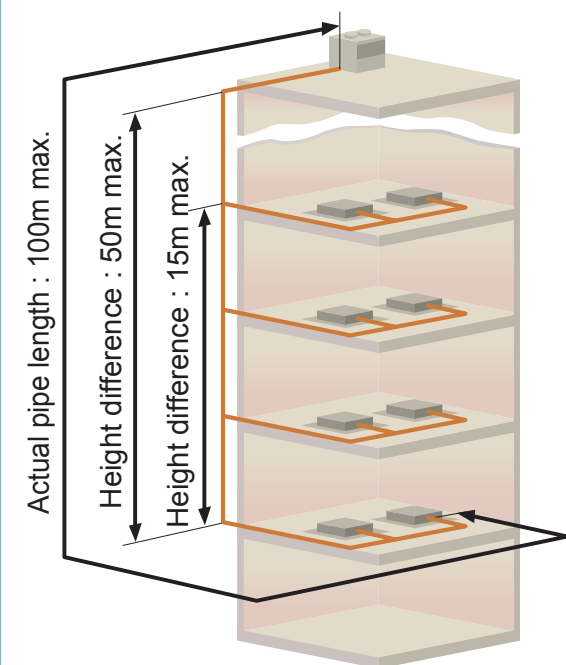

- Equivalent pipe length: 120m maximum.
- Total pipe length: 200m maximum.

### Maximum number of connectable indoor units

One outdoor unit can control up to 16 indoor units (28kW) or 13 indoor units (22.4kW) of different types and capacities.

Type	Capacity	Refrigerant		Max. connectable indoor unit
		R407C	R22	
Heat Recovery	28.0kW	AO90MPAMF	—	16
Heat Pump	28.0kW	AO90TPBMF	AO90RPBMF	16
	22.4kW	AO72TPBMF	AO72RPBMF	13
Cooling Only	28.0kW	AO90EPBMF	AO90APBMF	16
	22.4kW	AO72EPBMF	AO72APBMF	13

Connectable capacity of indoor units for one outdoor unit **50 to 130%**

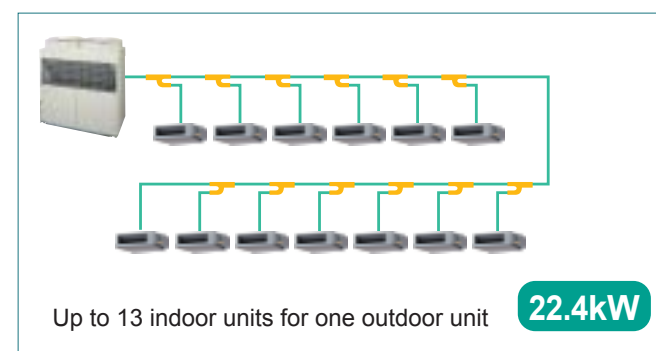
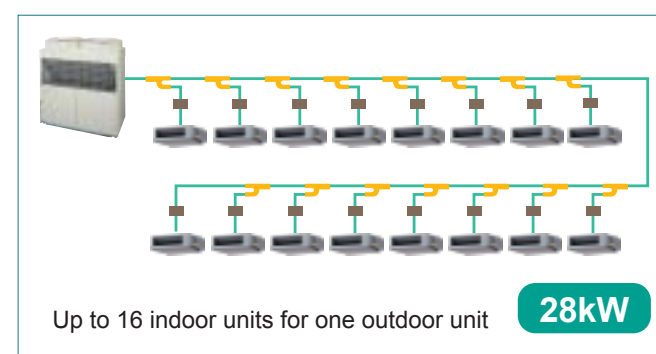

'Double auto swing' feature provides omni-directional air flow control.

### Wall Mounted Type

#### Models

AS18 / AS24 / AS30

#### Features

##### Multi air flow

Large independently driven power diffuser used

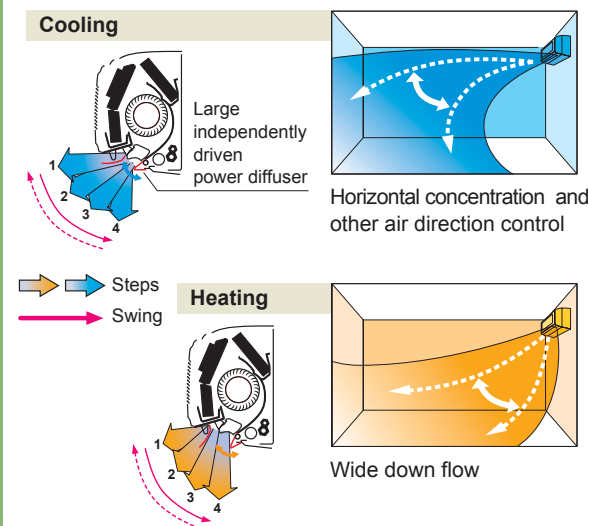

##### Low noise

- Hi : 44dB (Existing model : 47dB) - 24type actual data
- High efficiency fan construction ⇒  $\phi$ 7mm Lambda type evaporator improves the airflow path
- Large independently driven power diffuser

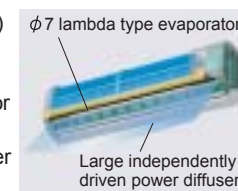

##### Easy installation

Larger space at base of housing means extra 15% piping space.

##### Others

- Other features include continuation of the functions of the existing wall mounted type.
- Double auto swing
- 2-way draining route



Attractive housing with discreet air intake.

### Ceiling Wall Type

#### Models

AW7 / AW9 / AW12 / AW14 / AW18 / AW24 / AW30

#### Features

##### High efficiency

High output and high efficiency are achieved by using a DC motor.

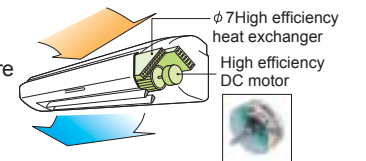

##### Larger, wider airflow

Introduction of the top air intake reduces the curvature of the air flow path thereby achieving lower air resistance, lower noise and larger air volume.

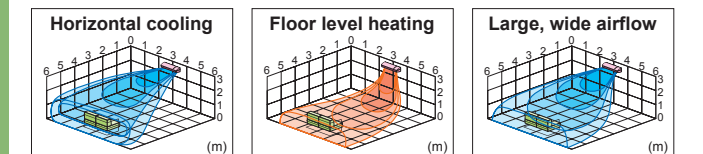

##### Easy maintenance

Drain pan can be easily removed for thorough washing without re-moving the unit from the wall.

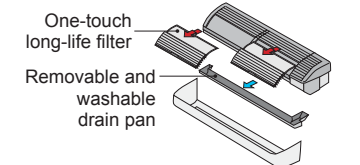

##### Low noise

Suppressing the turbulence by providing vertical grooves on the quiet louver and the right/left louver reduces annoying noise.



##### Long-life filter

- Long-life filter can be removed with one touch.
- Long-life filter extends the cleaning cycle by a factor of three.

##### Others

- Double auto swing/Right and left, up and down
- 2-way draining route
- Air purifying filter (Optional parts)



## Ceiling / Wall Mounted (Compact) / Wall Mounted / Ceiling Wall Type **igners**

HEAT PUMP & COOLING ONLY SERIES

HEAT RECOVERY SERIES

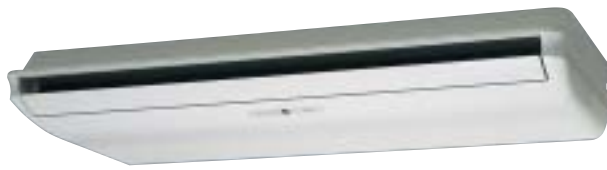

An ultra-slim design that offers a variety of installation methods, this indoor unit is lightweight and extremely quiet.

### Ceiling Type

#### Models

AB30 / AB36 / AB45 / AB54

#### Features

##### Installation

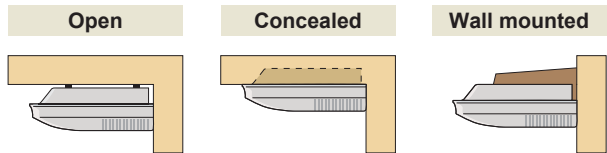

##### Condensate lift-up mechanism

Optional drain lift-up mechanism allows flexible installation.

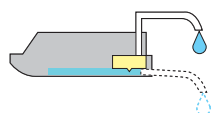

##### Double auto swing and wide air flow

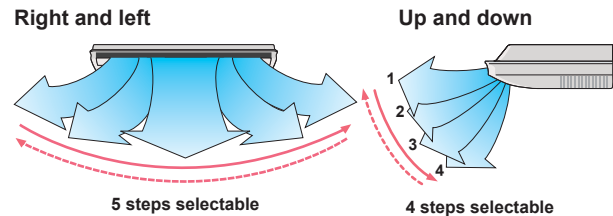

##### Fresh air intake

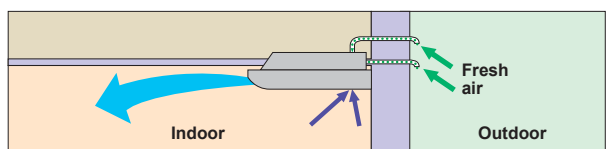

##### Long-life filter

High efficiency, long-life filter extends the cleaning cycle by a factor of two.

##### Optional parts

Drain water riser kit UTR-DPB241



Stylish and compact, these elegant wall-mounted units complement any interior decor

- This indoor unit can't be operated in the Heat Recovery Type System.
- AS7/AS9/AS12/AS14 are only available for wireless remote controller.

### Wall Mounted Type (Compact)

#### Models

AS7 / AS9 / AS12 / AS14

#### Features

##### Compact design

Powerful output despite small size

This compact wall mounted units have a powerful cooling capacity due to the large high pressure fan and lambda type heat exchanger.



##### Low noise level

The aerodynamic characteristics of the outlet louver contribute to a very quite indoor unit.

Fan speed	dB(A)
HIGH	30
LOW	26

(AS7)

##### Auto swing louver

The "Auto Swing Louver" feature ensures optimum airflow for each of the operating modes.

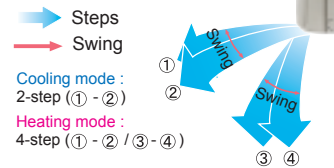

##### Washable panel filter

The removable and washable panel filter is an effective "air cleanser" removing mould and dust from the occupied environment.

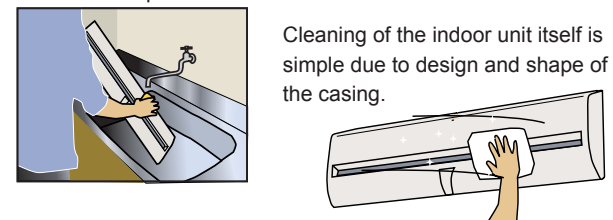

The top panel can also be removed for easy cleaning if necessary.

## Flexible Control System

### Flexible design

Flexibility is enhanced through the ability to connect outdoor units, indoor units and controllers anywhere within the data transmission line.

Maximum connectable number per one transmission line

Refrigerant system	100
Indoor units	400
Outdoor units	100

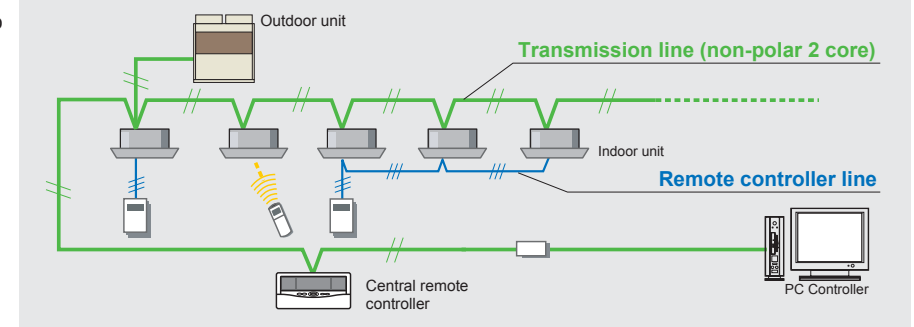

### Control options

A variety of control options are available within one VRF system. As the signal receiver is built into the indoor unit a mix of wired/simple/wireless remote controllers can be used simultaneously with the same indoor unit.

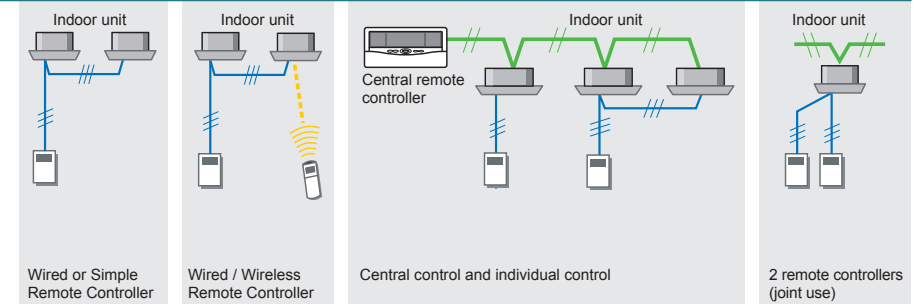

### Group control

This function is used when operating multiple remote controller groups at one time from a central remote controller or PC controller.

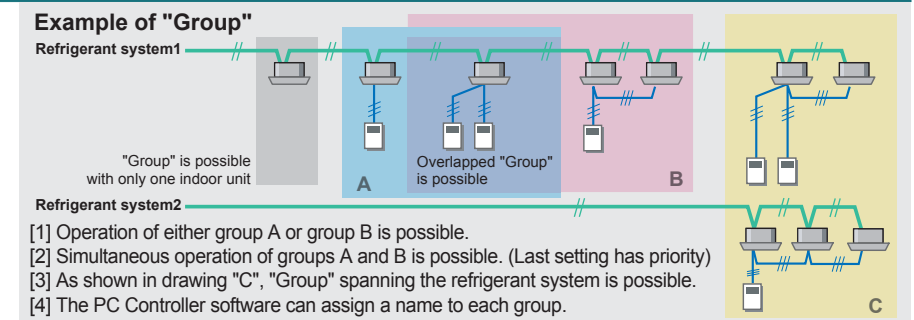

## Advanced Functions

### Interfacing system with external equipment

An output on the indoor PCB allows an auxiliary fan to be connected, possible to introduce outdoor air etc.

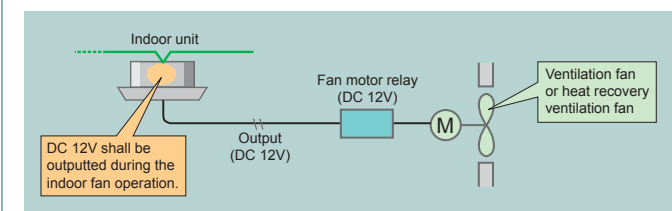

### Emergency turn off

Function for emergency turn off in case of fire or earthquake, etc.

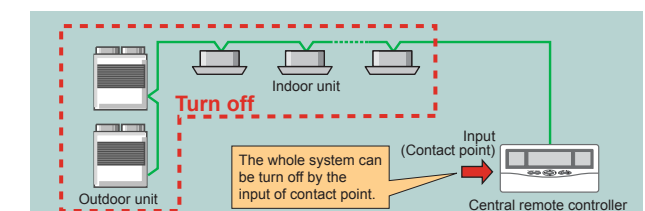

## For Installers

### Reduced Installation Work

#### Compact size

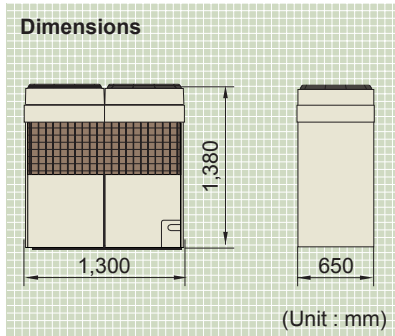

#### Outdoor unit goes into elevator

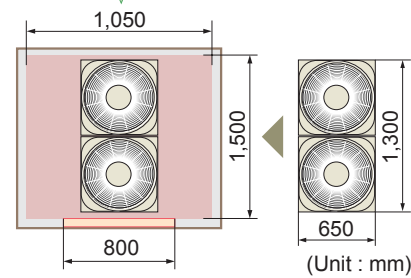

#### Space saving

Space saving by setting side by side without space in between.

Setting size **5.72 (Unit : m<sup>2</sup>)**



Offering one of the smallest footprints available the outdoor unit provides 84kW (28kW X 3) capacity within a very tight space.

#### Installation space

##### For individually

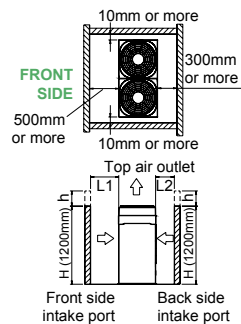

##### For continuous

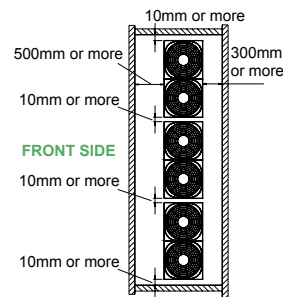

- There is no height restriction for the side wall.
- The height(H) of front and rear wall should be less than 1,200mm.
- If the height of wall exceeds 1,200mm by h mm, add h mm to the service space width for L1 and L2.  
 $H \leq 1,200$  :  $L1 \geq 500$ ,  $L2 \geq 300$   
 $H > 1,200 + h$  :  $L1 > 500 + h$ ,  $L2 > 300 + h$

#### Craning into place

The outdoor unit can be lifted by crane and set down on the building roof.

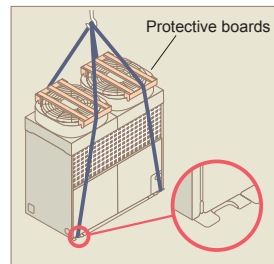

#### Piping connection

Four-direction piping allows a variety of installation configurations. Easy installation and pipe direction setting.

#### Four-direction pipe

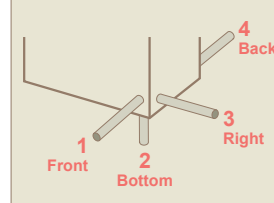

### Low Piping Costs

#### Simple piping system

The simple piping system reduces costs by increased piping flexibility.

##### Cooling Only & Heat Pump

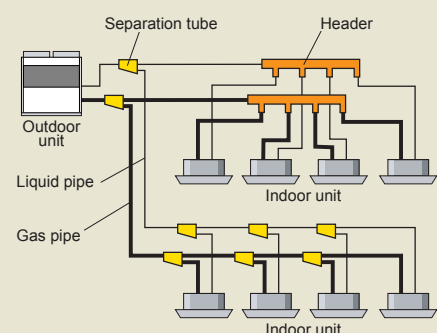

##### Heat Recovery

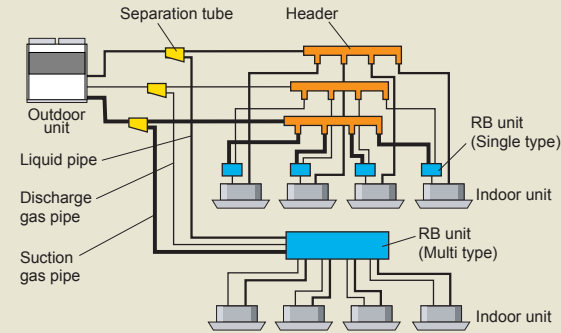

### versal Type

INDOOR UNIT



A high static pressure duct type indoor unit

#### High Static Pressure Duct Type

##### Models

AR36(H) / AR45(H) / AR60(H)

##### Features

#### Savings in space and reduction in noise

Installed in the ceiling void this model provides savings in space and reductions in noise.

A single indoor unit can serve several rooms.

#### Easy installation

The pipe can be connected in any direction by using the L-shaped auxiliary pipe.

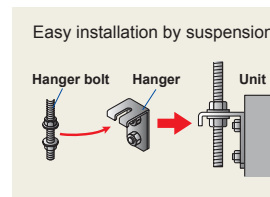
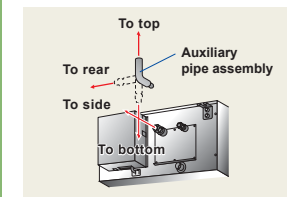

#### Easy maintenance

Fan motor maintenance can be performed from the top and the bottom.

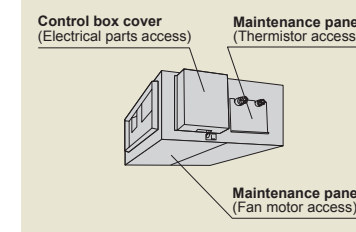
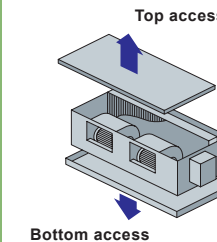

#### High static pressure

Recommended external static pressure : 196 Pa (Max. 300Pa)

#### Optional parts

Outlet chamber	UTD-BC200
Flexible duct	UTD-RD202
Long life filter	UTD-LF400
Remote sensor unit	UTD-RS100



The slim and lightweight design allows the unit to be suspended from the ceiling or installed at floor level.

#### Floor & Ceiling Universal Type

##### Models

AB12 / AB14 / AB18 / AB24

##### Features

#### Flexible installation

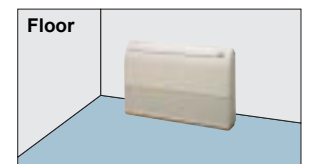
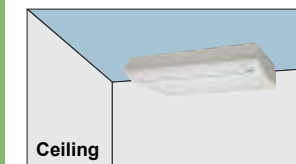

#### Compact design

Symmetrical, slim and compact design

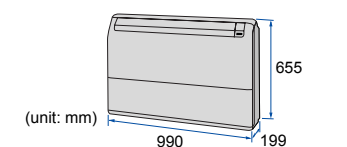

#### Double auto swing

A combination of up/down and right/left directional swing allows three-dimensional air direction control.

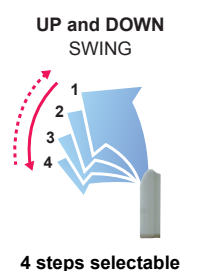
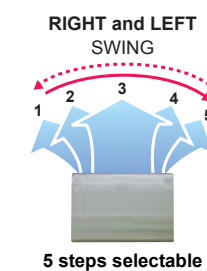

#### Super vane

Double-flap 'Super Vane' with newly developed special configuration boosts air flow sending cool air quickly to every corner of the room.

#### Auto-closing louver

This function is common to all indoor unit types except the duct type.



## Duct (Compact) / Duct / High Static Pressure Duct / Floor & Ceiling Uni

HEAT PUMP & COOLING ONLY SERIES

HEAT RECOVERY SERIES



Choice of installation  
Can be suspended from the ceiling or placed on the floor

### Duct Type (Compact)

#### Models

AR7 / AR9  
AR12 / AR14 / AR18

#### Features

##### Compact design

Ultra-slim duct air conditioner for easy installation



### Easy to install (Universal type)

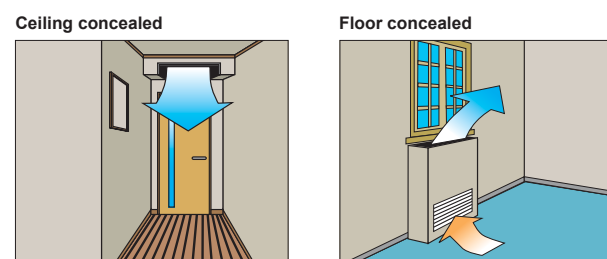

### Low noise level

A low noise level has been achieved for each capacity

Model		7	9	12	14	18
Static pressure (Normal/Max.)	Pa			0 / 39.6		
Volume of air-flow (High/Low)	m <sup>3</sup> / h	340/290	420/360	460/390	640/480	750/640
Noise level (Low speed)	dB(A)	26	31	26	30	33

### Optional parts

Remote sensor unit UTD-RS100



Ultra-slim duct air conditioner for very low ceilings

### Duct Type

#### Models

AR25 / AR30 / AR36 / AR45

#### Features

##### Savings in space and reduction in noise

Whether installed in the ceiling void or a false ceiling, this model provides savings in space and reductions in noise. A single indoor unit can serve several rooms.

### Flexible installation

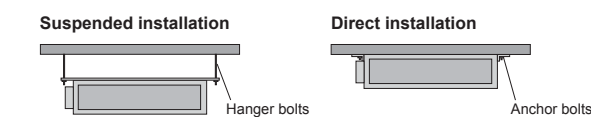

### Installation styles

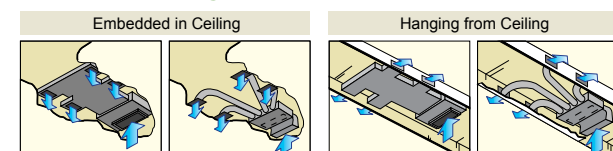

### Ultra-slim models for very low ceilings

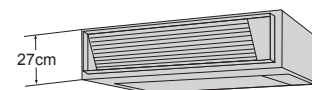

### Piping can be run in almost any direction

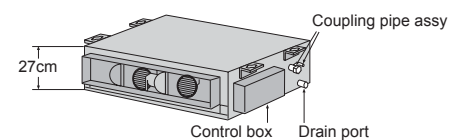

### Optional parts

Flange (square)	UTD-SF045T
Flange (round)	UTD-RF204
Flexible duct	UTD-RD202
Long life filter	UTD-LF270
Remote sensor unit	UTD-RS100

## Easy Wiring

### Transmission line

Non-polar 2-conductor transmission line prevents erroneous wiring.

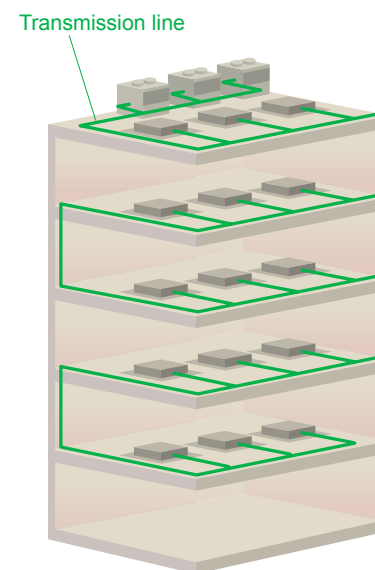

### Power supply wiring

Power supply for outdoor and indoor units is different.

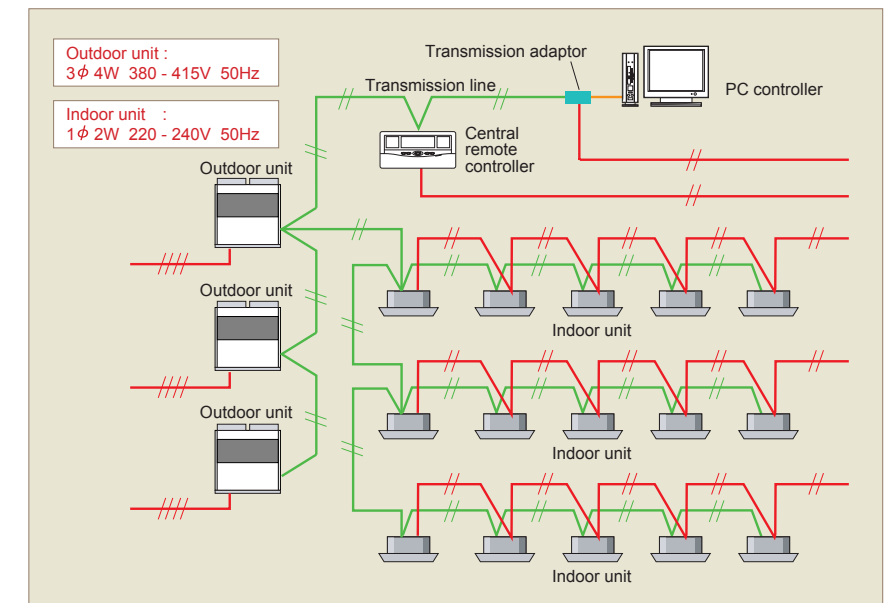

## Service Tool [Software] Model: UTR-YSTC

Service Tool can monitor the operation of the entire VRF system.

### Extensive monitoring and analysing functions

- Operational status can be checked and analysed to detect even the smallest abnormality.
- By storing system operation status in a PC, data can be checked even when offline.



## Easy Maintenance

### Operating display (outdoor unit)

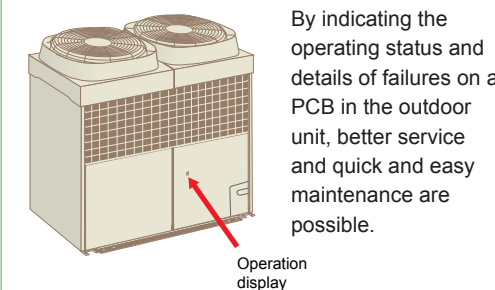

By indicating the operating status and details of failures on a PCB in the outdoor unit, better service and quick and easy maintenance are possible.

### Easy replacement

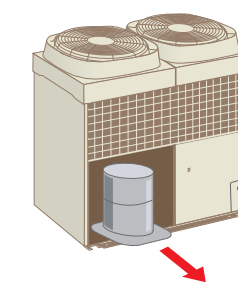

A pull-out plate ensures easy compressor replacement if necessary.

### Pump down control

Pump down can be performed from the outdoor unit using the switch on the PCB.

# VRF structure and features ensure



## Flexible Control System

### Features of control system

1. Reduced wiring as all system equipment accommodated on a single transmission line (non-polar 2-conductor).
2. Total wiring length (total length of transmission line) can be extended up to 2000m (by using signal amplifier units).
3. Maximum of 400 indoor units can be connected.
4. Indoor units can be controlled by wired, simple, wireless, group, central remote controller or PC controller.
5. Central control of single split type models (with exceptions) or big multi type air conditioners is possible from a central remote controller or PC controller.
6. Model combinations are dictated by the building's needs and not the system.
7. The 'simple' remote controller is ideal for installations such as hotel guest rooms.

### Control system reliability

1. Individual operation of the indoor units ensures that the failure of one does not affect the whole system.
2. Maintenance efficiencies are raised through the connection of a PC anywhere on the data transmission line.
3. Error codes can be clearly displayed on the wired remote controller, simple remote controller, group remote controller, central remote controller or PC controller.

### Configuration of control system

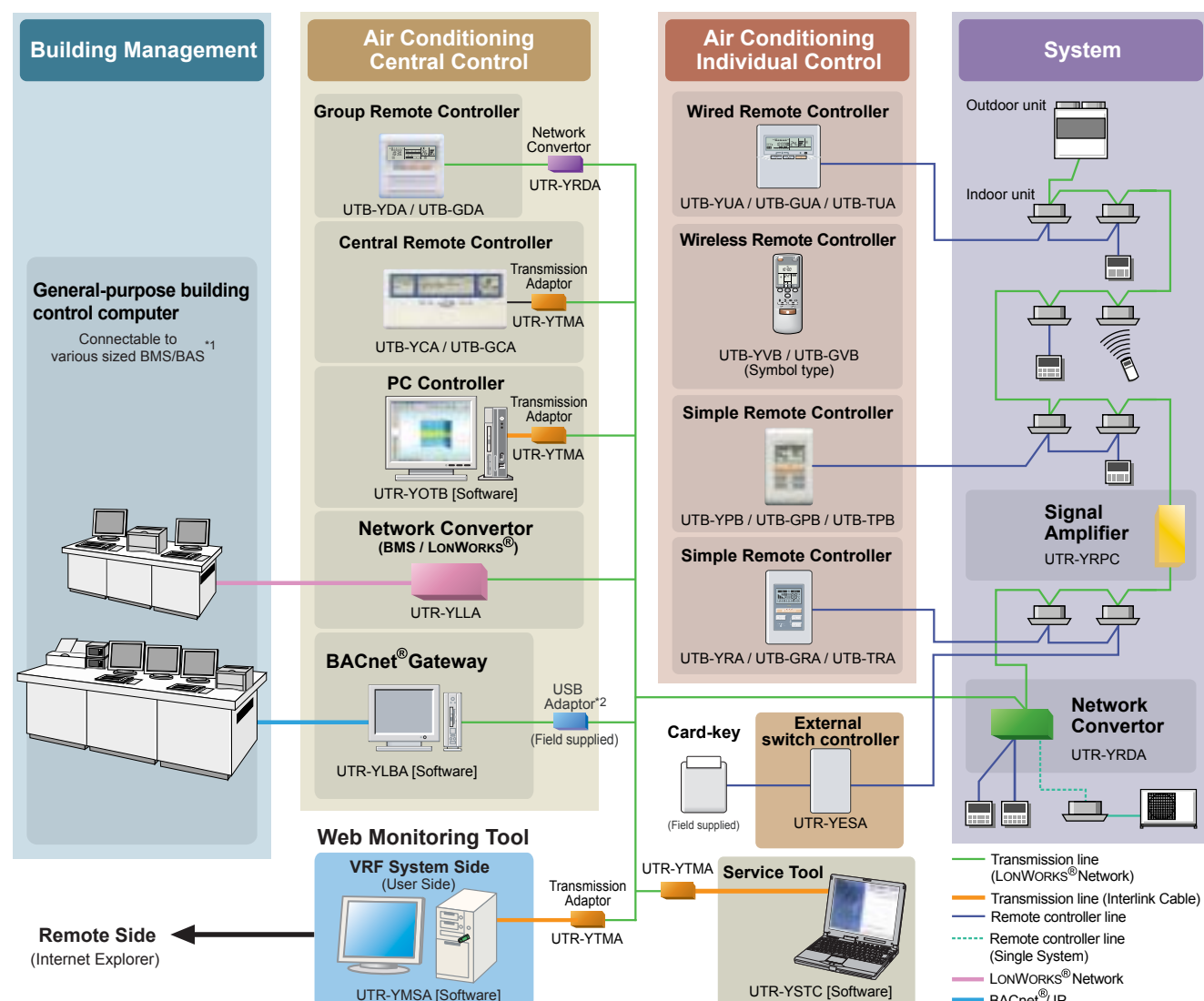

\*1. BMS/BAS: Building Management System / Building Automation System. Building Management System is supplied by the other vendors.  
 \*2. USB Adaptor is XLON® USB Adaptor of DH electronics company.



Slim cassette, designed for limited ceiling space

## Cassette Type

### Models

AU20 / AU25 / AU30 **Slim Type**  
 AU36 / AU45 / AU54

### Features

#### Flexible installation

Compact body ensures space saving installation. A slender fit option is available where ceiling void space is limited.

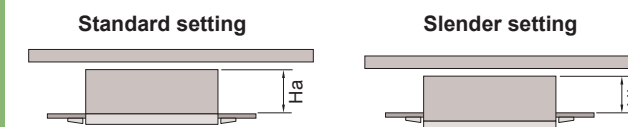

	Standard setting	Slender setting
AU20 / AU25 / AU30	Ha	Hb
AU36 / AU45 / AU54	285	250

#### Easy maintenance

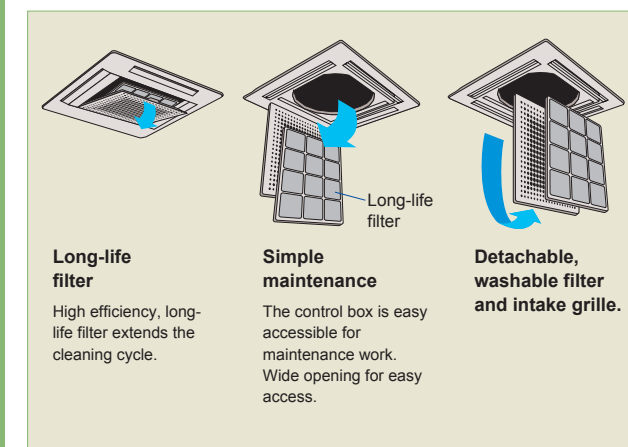

#### Condensate pump lift to 800mm



#### Comfortable air flow

##### 4-step swing

Auto air flow direction and auto swing

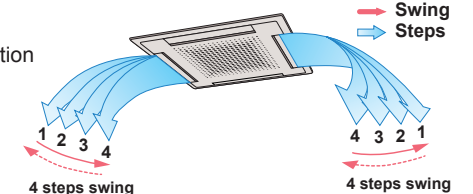

##### 2~4 way air flow system

Select 2-way, 3-way or 4-way air flow to suit your needs.

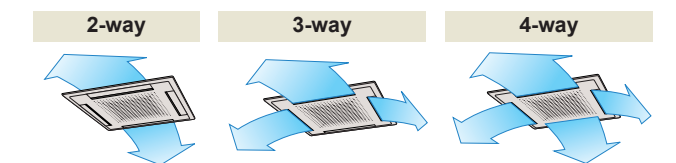

#### Wide air flow

Larger air flap distributes the outlet air flow a longer distance in the horizontal direction.

#### Duct connection hole opening

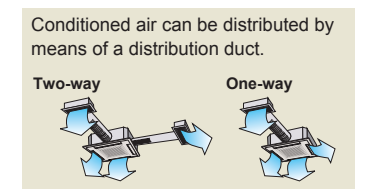
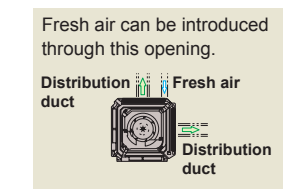

#### Improved noise level and air distribution

- Noise output has been dramatically lowered.
- Improved turbo fan shape (aerodynamic design)
- Expanded air distribution
- Low internal resistance
- Moulded fan motor

#### Air-flow volume can be switched

High ceiling mode (air flow up) and low-noise (air flow down) can be switched according to the height of the ceiling and other conditions by means of a PCB DIP switch.

	Standard	High 1 ceiling	High 2 ceiling	Low ceiling
Suitable ceiling height (m)	2.5—3	3—3.5	more than 3.5	less than 2.5

#### Draught prevention

Movement of the flap angle can be changed via a simple switch during installation, thereby preventing uncomfortable draughts.

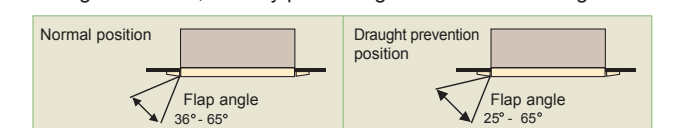



## Cassette (Compact) / Cassette Type

# flexible control



Compact design for easy installation and maintenance

### Cassette Type (Compact)

#### Models

AU7 / AU9 / AU12 / AU14 / AU18

#### Features

##### Compact size

Compact grille fits European ceiling panel (600 x 600 mm).

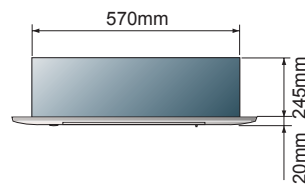
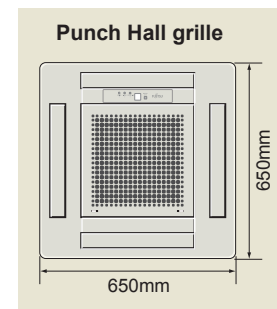

##### Comfortable air flow

**4-step swing**  
Auto air flow direction and auto swing

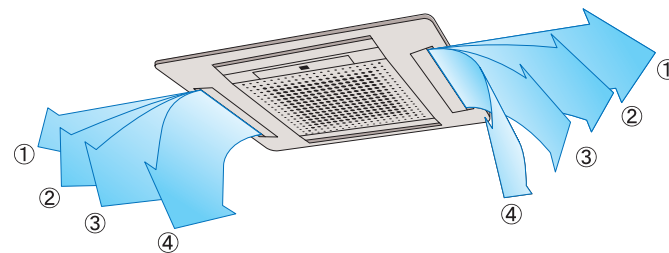

##### 2-4 way air flow system

Select 2-way, 3-way or 4-way air flow to suit your needs.

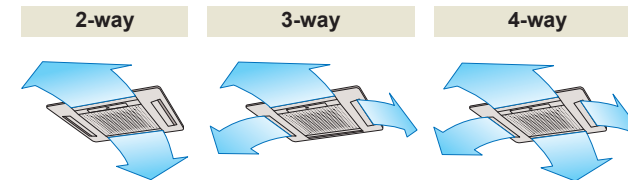

##### Easy maintenance

By placing the electrical component box inside the unit easy maintenance is assured.

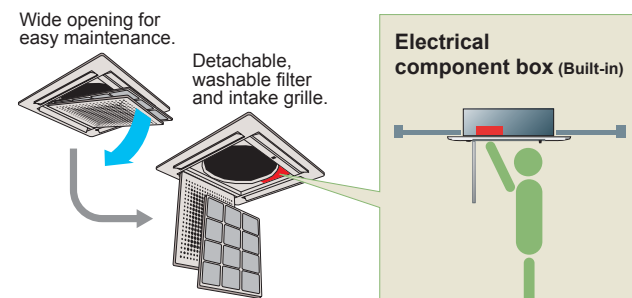

##### Condensate pump lift to 400mm

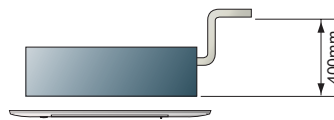

##### Low noise

Large air flow at reduced noise output achieved by incorporating a large diameter variable pitch turbo fan.

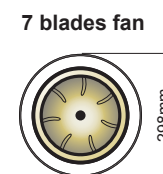

##### Draught prevention

Movement of the flap angle can be changed via a simple switch during installation, thereby preventing uncomfortable draughts.

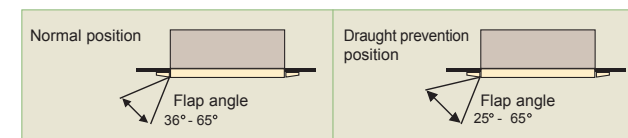

## Construction of Wiring System

Wiring configuration of the control system is made of power source wiring, transmission wiring and remote controller wiring.

### System Diagram

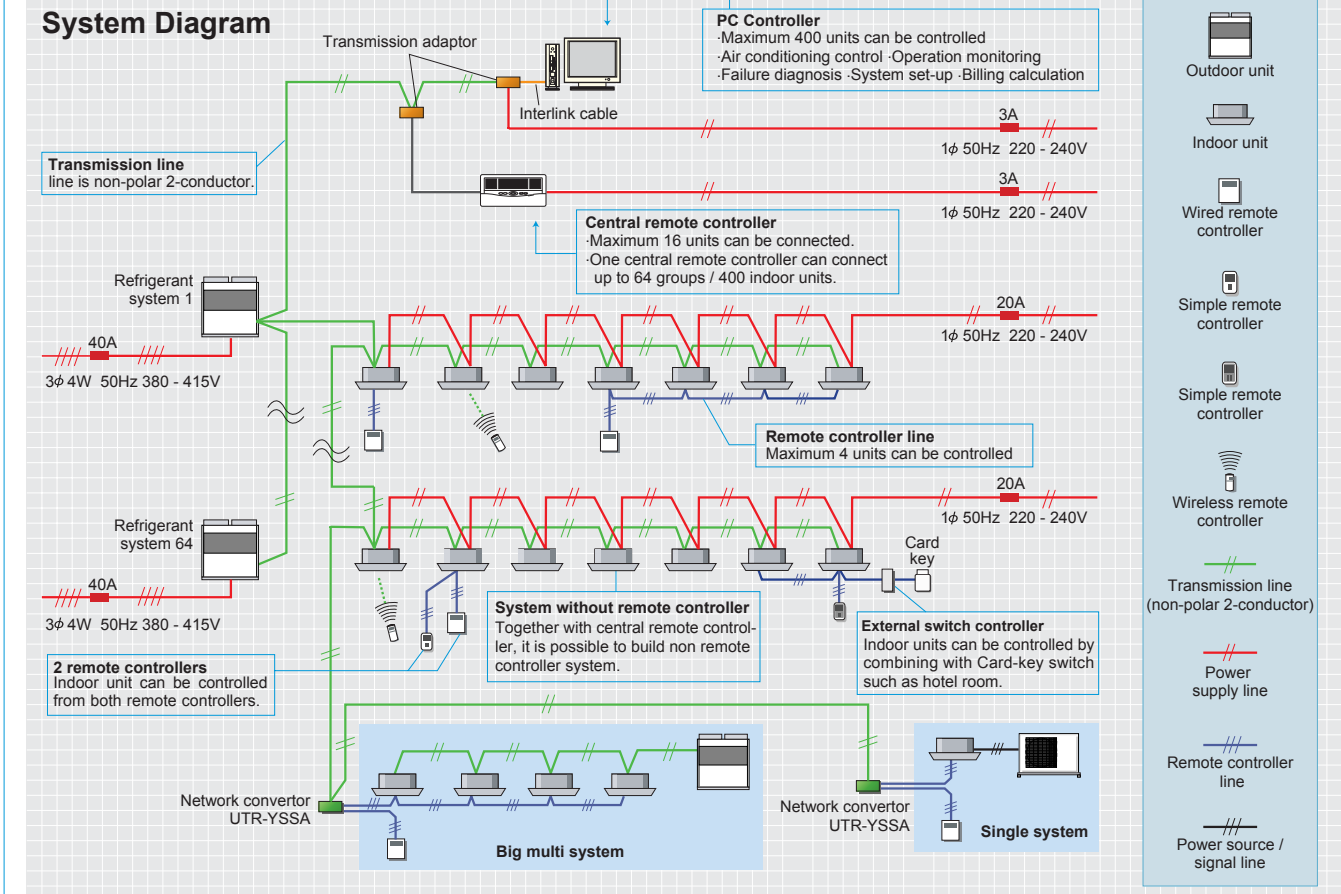

#### Maximum connectable number per one transmission line

Refrigerant system	100
Indoor units	400
Outdoor units	100

#### Combination of local remote controller

Wired, wireless and simple remote controllers can be used jointly.

## Building Management System (BMS) Compatibility

It is possible to control not just the air conditioning system but the whole building management system including lighting and electrical facilities, hydraulic systems, fire alarm interface, security systems, etc.

### Monitoring & Controlling for VRF system

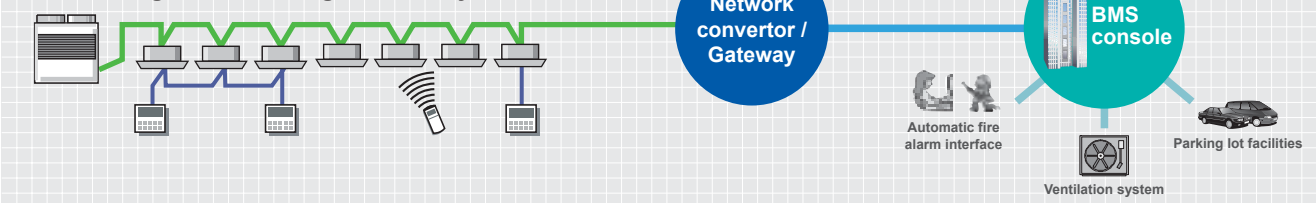

# Controller features

## Air conditioning central control

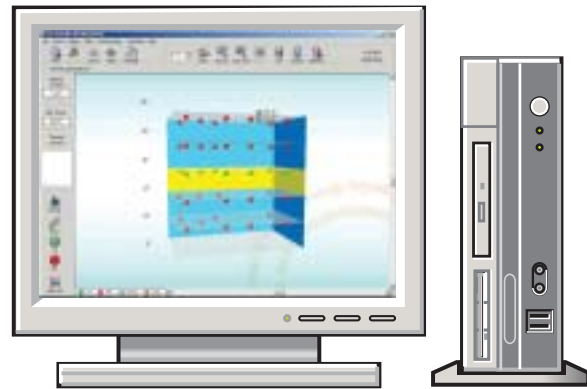

### PC Controller [software] UTR-YOTB [Option]

#### High performance and optimum control system for various building applications

- Up to 400 indoor units/400 groups/64 remote controller groups can be connected into one system for large scale buildings or hotels.
- Provides powerful functions for building air conditioning management, including automatic calculations of electrical costs and numerous data management functions, as well as standard equipment monitoring and control.

## Functions

### Central building monitoring and control

- Detailed settings can be programmed for each whole building/group/remote controller group or individual indoor unit.
- The PC and central remote controller can be used together, allowing system control from two or more locations if required.

### Central control

The 6 functions of the standard controller can be locked from the PC: all functions, timer mode, operating mode, temperature setting, filter reset, on/off. All functions can be controlled via the PC Controller only.

### Auto mode (Priority-mode changer)

Auto mode function automatically switches between cooling and heating modes based on the temperatures set and the room temperature detected by the master indoor unit. Other operating indoor units can be operated in the same operating mode as the master indoor unit.



Operation Control

## User-friendly Operation

- Runs under Windows® 2000 and Windows® XP Professional / Home so is as easy to use as a standard PC.
- Operational status can be colour-coded for instant recognition: On/green, Off/red, test/orange, error/flashing.
- Operational status can be displayed to user's preference.



**Rotating 3-D Display**  
When monitoring and controlling the operation by whole building.



**Floor Layout Display**  
When monitoring and controlling the operation by each floor or group.



**List Table Display**  
When monitoring and controlling each unit in detail.

Floor & Ceiling Universal Type	Ceiling Type	Wall Mounted Type (Compact)	Wall Mounted Type	Ceiling Wall Type
 Model AB12 / AB14 / AB18 / AB24 see page 29	 Model AB30 / AB36 / AB45 / AB54 see page 30	 • This indoor unit can't be operated in the Heat Recovery Type System. Model AS7 / AS9 / AS12 / AS14 see page 30	 Model AS18 / AS24 / AS30 see page 31	 Model AW7 / AW9 / AW12 / AW14 / AW18 / AW24 / AW30 see page 31
	●			
	●			
	●			
	●		●	●
●			●	●
●		●	●	●
●		●		●
●		●		●
		●		●
		●		●

### Linking with external control equipment is possible.

Diverse air conditioning control systems linked with various equipment inside the building can be built by using the external I/O port.

### Prevents wireless remote controller interference

The signal cord of the wireless remote controller can be switched and prevents erroneous operation by interference between adjacent indoor units.

### Simple external appearance by auto shut flap

Gap-free, flat, and simple external appearance by closing of the flap when operation stops.

### Symmetrical design

Left and right symmetrical design harmonizes with any interior design and creates a tranquil atmosphere.





## Full Range of Indoor Units

A full and complete range of indoor units is available

Capacity	Type		Cassette Type (Compact)	Cassette Type	Duct Type (Compact)	Duct Type	High Static Pressure Duct Type
	(kW)	(BTU/h)	Model AU7 / AU9 / AU12 / AU14 / AU18	Model AU20 / AU25 / AU30 ( Slim Type ) AU36 / AU45 / AU54	Model AR7 / AR9 Model AR12 / AR14 / AR18	Model AR25 / AR30 / AR36 / AR45	Model AR36(H) / AR45(H) / AR60(H)
17.00	60,000	see page 26	see page 27	see page 28	see page 28	see page 29	●
14.10	54,000		●				
12.70	45,000		●		●	●	●
10.50	36,000		●		●	●	●
8.80	30,000		● Slim Type		●		
7.05	25,000		● Slim Type		●		
6.80	24,000						
5.70	20,000		● Slim Type				
5.30	18,000	●		●			
4.05	14,000	●		●			
3.60	12,000	●		●			
2.80	9,000	●		●			
2.15	7,000	●		●			

### Common features

#### Room temperature feedback control

Comfortable temperature control can be achieved by feedback control of intake air temperatures and the opening of electronic expansion valve.

Room-temperature feedback control

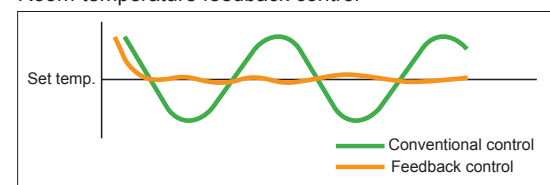

#### Energy saving operation

Energy saving operation is possible by changing the operation capacity according to the remote controller's setting.

**COOLING operation :**  
The thermostat setting is automatically raised 1°C every 60 minutes, until the thermostat is raised a total of 2°C.

**HEATING operation :**  
The thermostat setting is automatically lowered 1°C every 30 minutes, until the thermostat is lowered a total of 4°C.

#### Auto-Changeover

The unit automatically switches between heating and cooling modes based on your temperature setting and the room temperature.

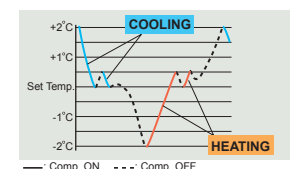

\*It is only available for heat recovery type.

### Calculating electrical costs

- Total electrical costs, billed for multiple indoor connected to the charge meter for air conditioning, is apportioned according to the accumulated refrigerant time and indoor unit capacity.
- Allows accounting for special rates (e.g., for night or weekend use).
- Calculations can be printed as final bills.

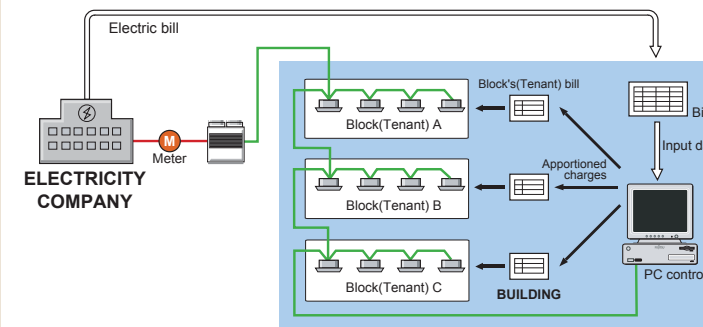

### Error display

Audible alarms are accompanied with explanatory text. Up to 100 alarms can be recorded for each piece of equipment, particularly useful during maintenance.



### Operating record

The operating status of indoor units and accumulated operating time of outdoor units can be recorded and a daily or monthly report produced.



### Schedule control

- Annual schedules can be set for each remote controller group.
- Start/stop, operating status and temperature settings can be recorded up to 72 times per day at 10 minute intervals for up to 6 configurations for each remote controller group.
- Setting over midnight is possible.
- Holiday settings including public holidays for a complete year can be programmed.
- The 6 functions of the standard controller can be locked by schedule control.



### Pattern setting

It enables to recognize operation status, such as ON/OFF, operation mode and set temperature, as a combination pattern. An arbitrarily pattern operation can be done with just one button clicking.

## Easy Installation

- Simple connection by Transmission Adaptor and Interlink cable ( Interlink cable field supplied ).
- Simple installation of software using only the CD supplied.

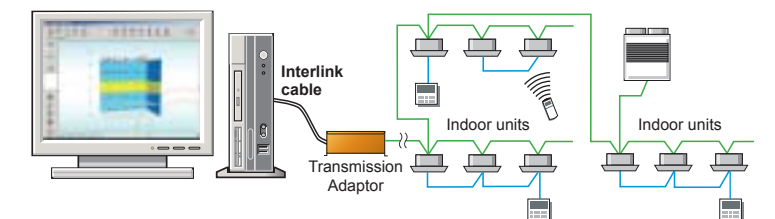

### Requirements of PC for this software

Personal Computer	Operating System	AT compatible machine that runs Microsoft®Windows® Microsoft® Windows®2000 Professional (English version / Service pack3 or later) Microsoft® Windows®XP Professional / Home (English version / Service pack1 or later)
	CPU	Intel®Pentium®/ Celeron®, AMD Athlon™/ Duron™1GHz or higher
	HDD	4GB or more
	Memory	256 MB or more
	Interface	Serial port and USB port
Accelerator	Requires that the internal graphics accelerator be compatible with Microsoft®DirectX®7.0 or later	
Software		Adobe®Acrobat®Reader 4.0 or later
Hardware		Interlink cable (D-sub 9pin female connector) (Parts No.: KRS-L09-4K) [Field supplied]

#### <PACKING LIST>

Packing List	Software protection key / CD-ROM / Transmission Adaptor
--------------	---



## Controller features

### Air conditioning central control



### Central Remote Controller

UTB-YCA / UTB-GCA [Option]

#### Functionality in a compact housing with built-in weekly timer

- Up to 400 indoor units/400 remote controller groups/64 groups can be controlled by one system.
- Up to 16 central remote controllers can be connected into one system allowing operation and monitoring to be achieved from the central control room, at each floor, by each tenant, or in the plant room.

## Functions

### Control up to 400 indoor units

- Central remote controller can control the system by selecting All Groups, User Defined Groups or Individual Remote Controller Groups
- Accurate control of functions such as Start/Stop, Operating Mode, Temperature, and Air Velocity ensures occupancy comfort.

### Central control

The 6 functions of the standard remote controller can be locked from the Central Remote Controller: all functions, timer mode, operating mode, temperature setting, filter reset, on/off. All functions can be controlled via the Central Remote Controller only.

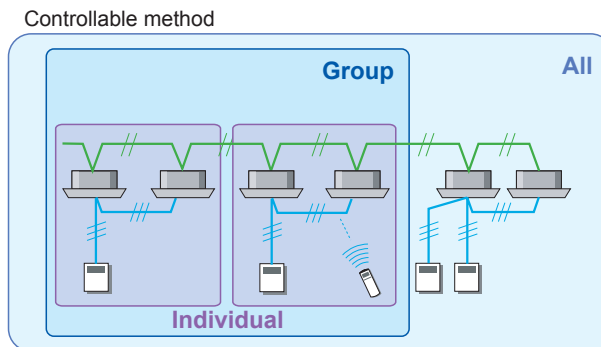

## Easy Operation

- Control functions are divided into three clusters: Timer Control, Central Control and Operational Control, which are clearly displayed.
- A large liquid crystal display clearly indicates which indoor unit is currently in operation.

ALL-050

All Control Mode

GROUP-001

Group Control Mode

REC GROUP-001

Individual Control Mode

TIMER CONTROL AREA

CENTRAL CONTROL AREA

OPERATION CONTROL AREA

### Simple Remote Controller

UTB-YPB / UTB-GPB / UTB-TPB [Option]

UTB-YRA / UTB-GRA / UTB-TRA [Option]

#### Simple remote controller concentrating on the basic operations.

- Up to 4 indoor units can be controlled with one remote controller.
- Suitable for hotels or offices which have many visitors coming in and going out and do not require detailed functions.



UTB-YPB / UTB-GPB / UTB-TPB    UTB-YRA / UTB-GRA / UTB-TRA

<b>Dimension (H x W x D) (mm)</b>	120 x 75 x 14
-----------------------------------	---------------

#### User friendly operation

- Concentrates on the basic operations such as On/Off, Fan Control, Operation Mode Switching, and Temperature Setting.
- A large Start/Stop button is provided in the centre of the remote controller unit for easy operation.
- Simultaneous use with standard remote controller.
- Diagnostics are carried out during the 'stop' mode following an error display.

#### Back ground light

- Backlight enables easy operation in a darkened room.
- The backlight is lit during the button operations, and also 10 seconds more in operation mode and 5 seconds more in stop mode.



#### Simple installation work

- Can be mounted on the European Mounting Box (Installation dimension: 60mm) or the JIS Built-in Box (Installation dimension: 83.5mm).

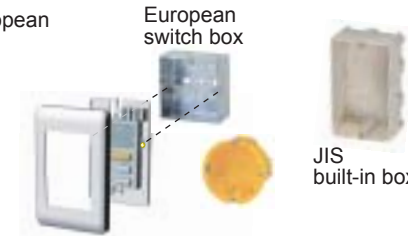

#### Functions

Model	UTB-YPB UTB-GPB UTB-TPB	UTB-YRA UTB-GRA UTB-TRA
Operation	●	●
On/Off	●	●
Fan control	●	●
Operation mode	●	—
Temp. setting	●	●

### External Switch Controller

UTR-YESA [Option]

- ON/OFF, Temperature, Fan speed and Operation mode can be switched by a combination with Card-key switch equipped in facilities such as hotel room.
- Switching of air conditioner can be controlled by connecting other sensor switches.

\*Card-key and other sensor switches are available as a field supplied parts.

<b>Dimension (H x W x D) (mm)</b>	120 x 75 x 30
-----------------------------------	---------------

#### Electrical wiring

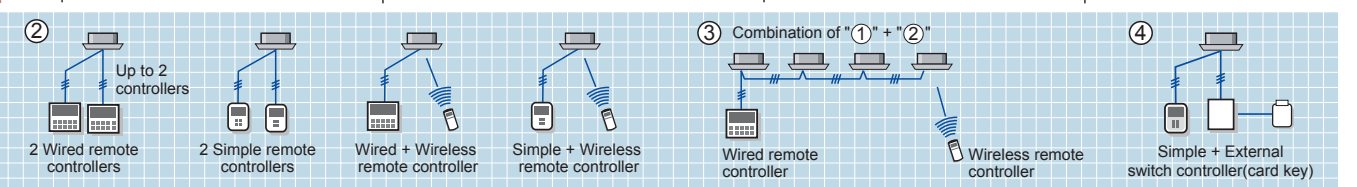
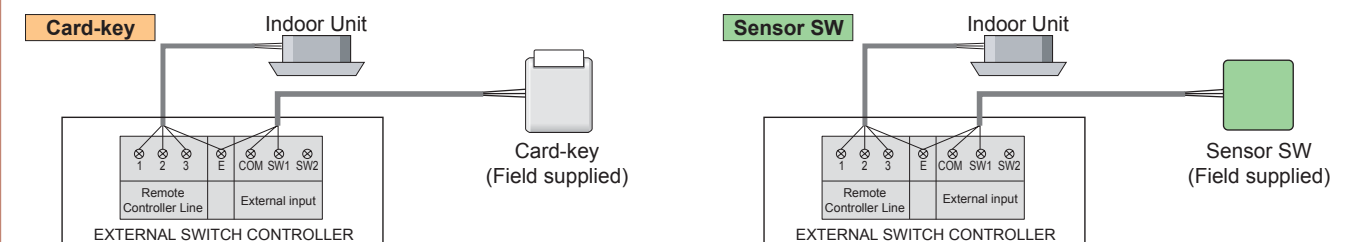





## Controller features

### Air conditioning individual control



UTB-YVB / UTB-GVB  
Symbol type

### Wireless Remote Controller

UTB-YVB / UTB-GVB [Option] Symbol type

Simple Operations with a Choice of 4 Daily Timers

<b>Dimension</b> (H x W x D) (mm)	158 x 56 x 20
-----------------------------------	---------------

#### Built-in daily timer

Select from 4 different timer programs : On / Off / Program / Sleep

##### Program Timer :

The program timer operates the ON and OFF timer once within a 24 hour period

##### Sleep Timer :

The sleep timer function automatically corrects the set temperature according to the time setting to prevent excessive cooling and heating while sleeping.

##### Cooling operation/dry operation

When the sleep timer is set, the set temperature automatically rises 1°C every hour. The set temperature can rise up to a maximum of 2°C.

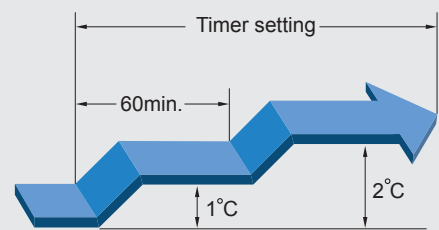

##### Heating operation

When the sleep timer is set, the set temperature automatically drops 1°C every 30 minutes. The set temperature can drop to a maximum of 4°C.

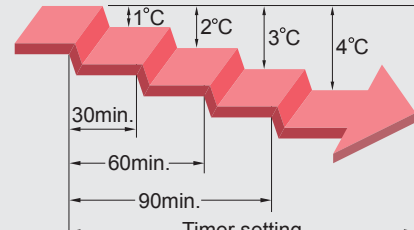

#### Easy installation and operation

Code selector switch prevents indoor unit mix-up. (Up to 4 codes can be set.)

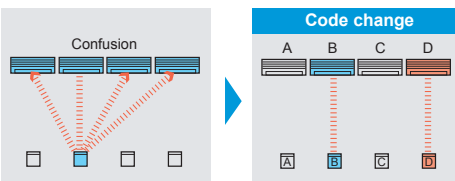

Wide and precise transmitting range.

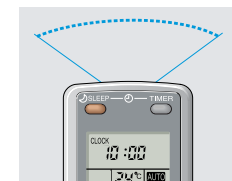

1. Press the MASTER CONTROL button for more than five seconds to start the code change.
2. Press the (+) or (-) button to select the desired code.  
A → B → C → D
3. Press the MASTER CONTROL button again to end the code change.

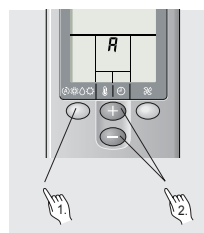

### Standardization and simultaneous use of remote controllers

Wired, simple and wireless remote controllers can be used with the same indoor unit. Simultaneous use is also possible. A separate signal receiver kit is not required as the remote controller signal receiver is built into the indoor unit body.

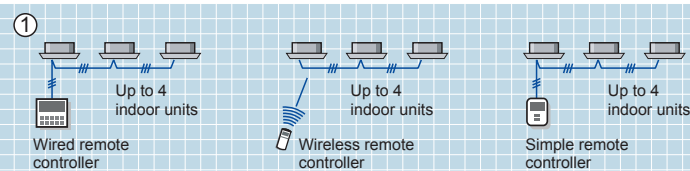

#### Built-in weekly timer

- The timer function, which can control up to 400 indoor units, provides detailed scheduling for each remote controller group.
- A simple approach to system configuration reduces wiring costs.

1. Possible to set different ON / OFF time twice a day for each day of the week.
2. Possible to set time in 10 minutes steps.
3. Time operation for a reserved day can be cancelled temporarily by pressing the "DAY OFF" button in advance.
4. Time setting can be carried over to the next day.
5. Copy and Paste can be used for time settings for each day.

##### Weekly schedule

Example : Office

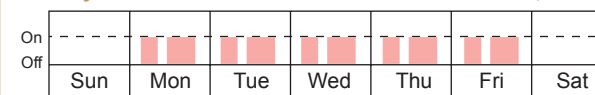

Operation : Monday~Friday 8:00~12:00 and 13:00~18:00

#### Error display

Up to 62 error codes can be displayed. The last 2 error codes can be displayed, allowing easy inspection, service and maintenance.

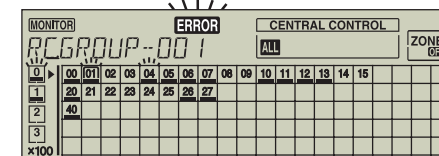

#### Advanced functions

##### Anti Freeze :

In cold regions, room temperature drops at night. This function prevents freezing of the water and other parts. When the room temperature drops to 5°C or less the heating is automatically switched on. Then the room temperature reaches 8°C the heating automatically switched off.

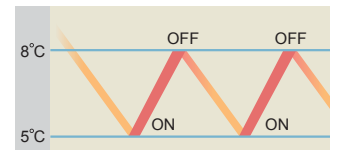

##### Energy Saving Operation :

During COOLING operation When the ENERGY SAVE is pressed, the thermostat setting is automatically raised 1°C every 60 minutes, until the thermostat is raised a total of 2°C.

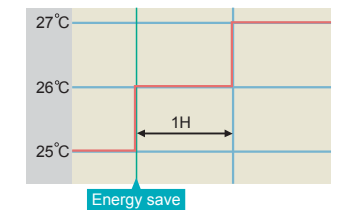

During HEATING operation When the ENERGY SAVE is pressed, the thermostat setting is automatically lowered 1°C every 30 minutes, until the thermostat is lowered a total of 4°C.

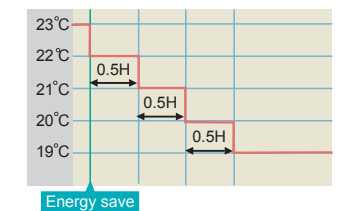

**Memory :** Central remote controller maintains original settings for indoor units. This data can easily be transmitted to the system even after the operating conditions have been changed.

## Simple and Convenient Installation

- The controller can be installed on any flat surface.
- The control panel and transmission adaptor can be installed separately.
- For flexibility in installation, the main unit can be built into the wall or exposed.

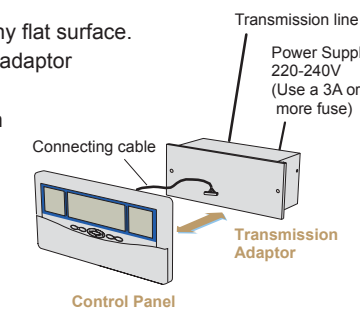

#### Setting Example (1)

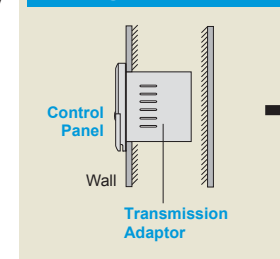

#### Setting Example (2)

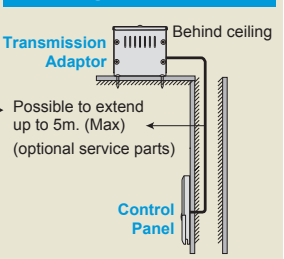

#### Specifications

	UTB-YCA / UTB-GCA	
	Control Panel	Transmission Adaptor
Power Supply	DC 12V	220-240V 50-60Hz Single phase
Power Consumption (W)	4.8	4.8
Fuse Capacity (A)	3	3
Dimension (H x W x D)(mm)	143 x 296 x 22	107 x 288 x 100
Weight (g)	550	1300
Packing Size (H x W x D)(mm)	—	145 x 330 x 190
Transmission Line	—	Shielded Non-polar, 2 core cable

#### <PACKING LIST>

Packing List	Control Panel / Transmission Adaptor / Connecting Cable
--------------	---



## Controller features

### Air conditioning central control



### Group Remote Controller

UTB-YDA / UTB-GDA [Option]

Group control of indoor units with simple operation

- Up to 8 indoor units can be controlled with a single controller.
- Up to 64 Group Remote Controllers can be connected in a single VRF system.

## Controller features

### Air conditioning individual control

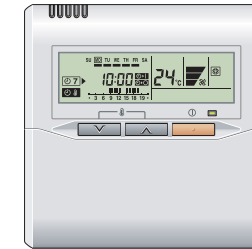

### Wired Remote Controller

UTB-YUB / UTB-GUB / UTB-TUB [Option]

Simple Operation with Built-in Weekly / Daily Timer

- Up to 4 indoor units can be controlled with 1 controller.
- Up to 2 wired remote controllers can be connected to 1 indoor unit.

<b>Dimension</b> (H x W x D) (mm)	120 x 120 x 17
-----------------------------------	----------------

• Build-in thermo sensor doesn't work in S series system.

#### Control up to 8 indoor units

- Control and monitoring of up to 8 indoor units is possible with a single Group Remote Controller.
- Up to 64 Group Remote Controllers can be connected in a single VRF system.
- 4 Group Remote Controllers can be connected to a single Network Converter (UTR-YRDA).
- A single Network Converter (UTR-YRDA) covers 2 refrigerant circuits.

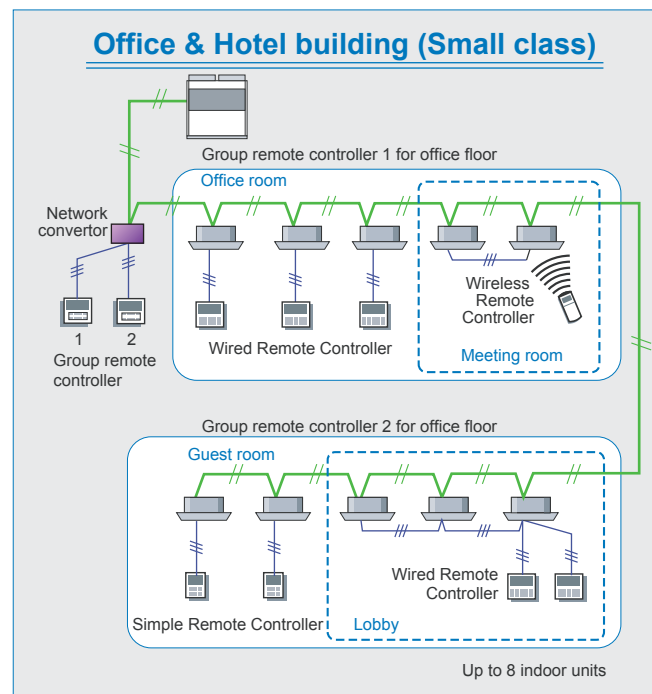

#### High performance and compact size

- ON/OFF, operation mode, set temperature and air flow can be controlled / monitored centrally or individually.

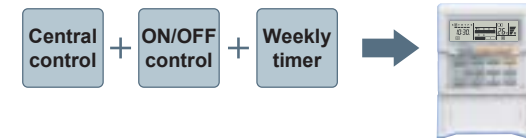

#### Built-in weekly timers

The WEEKLY TIMER is provided as a standard function.

1. The timer can be set up for up to 4 times/day. (On/Off, operating mode, set temperature)
2. Allows separate settings for each day of the week.

**ON/OFF switching**

**Cooling/Heating switching**

**Temperature switching (Peak cut)**

**Temperature switching (Anti-freeze)**

**Stop setting**

#### Powerful features and compact size

This wired remote controller incorporates three primary functions into a single unit.

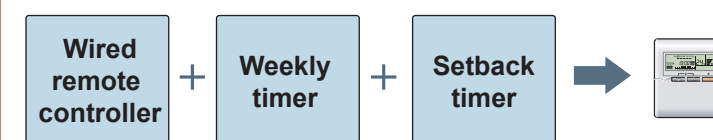

#### Easy-to-understand operation

##### Diverse timer control

The operation / display section are zoned into a timer area and an operation area. Also, the ON/OFF timer uses a remaining time feature and allows diverse timer settings corresponding to the application.

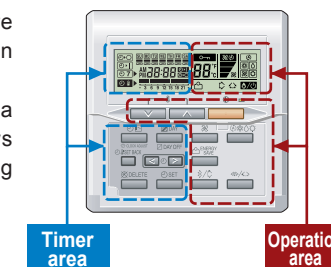

#### Built-in timers

##### Weekly timer :

Two ON/OFF times can be set for each day of the week.

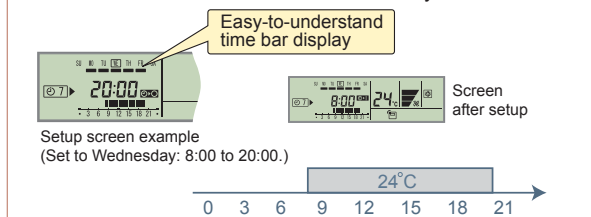

##### Setback timer :

Allows the user to set temperatures for two time spans over the course of each day of the week.

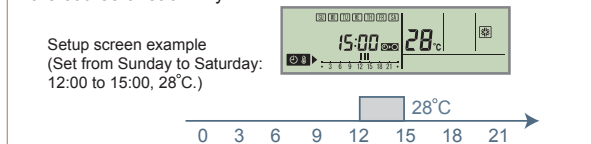

##### At "Weekly timer" + "Set back timer" setup :

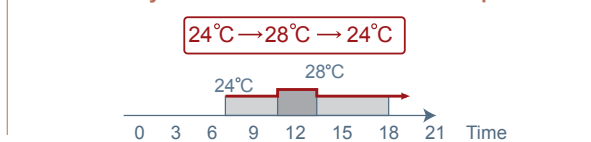

#### Energy Saving Operation

Energy saving operation is possible by changing the operation capacity according to the remote controller's setting. (See details on page 24)

#### Simple installation work

Can be mounted on the European Mounting Box (Installation dimension: 60mm) or the JIS Built-in Box (Installation dimension: 83.5mm).

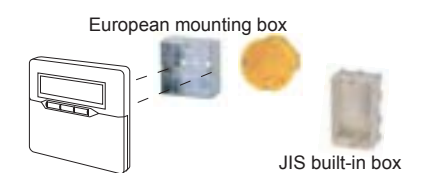

#### Specifications

Model	Group Remote Controller		Network Converter	
	UTB-YDA / UTB-GDA		UTR-YRDA [Option]	
Power Supply	DC 12V		220-240V 50-60Hz	
Dimension (mm)	Height	120	67	
	Width	120	288	
	Depth	20	211	
Weight (g)	200		1,400	

#### Diagnosis check function

There are two methods for interrogating the cause of failure when a malfunction occurs:

##### Malfunction diagnosis function :

Should an abnormality occur during system operation, the error code of the connected indoor units can be displayed.

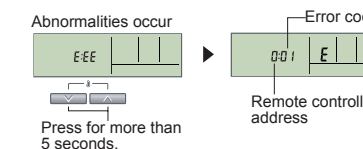

##### Error history :

The last 16 error codes can be accessed via the controller. This is useful for troubleshooting system abnormalities and helpful for determining error causes.

